

# Livinglight



**KATALOG  
2018**



**BTICINO** uygulamasını indirerek anahtar mekanizmalarınızı AXOLUTE veya LIVINGLIGHT olarak tasarlayabilirsiniz.

Uygulama, iPhone, iPad (iOS) ve Android cihazlar için bulunmaktadır.



■ UYGULAMAYI BAŞLATIN



■ İSTEDİĞİNİZ LIVINGLIGHT ANAHTARINI TASARLAYIN

Uygulamaya ulaşmak için telefonunuzda bulunan QR kod okuyucusunu kullanabilirsiniz.



IPHONE



ANDROID

## İçerik

2-30	Genel özellikler	LIVINGLIGHT	2
		LIVINGLIGHT AIR	4
		LIVINGLIGHT Dikdörtgen çerçeveler	6
		LIVING INTERNATIONAL	7
		Mekanizma tasarımları	8
		Yeni nesil elektromekanik mekanizmalar	9
		Otomatik bağlantılı mekanizmalar	10
		Yeni AXIAL anahtar	11
		Dimmer	12
		Dimlenebilen mobil lambalar	13
		Dimlenebilen okuma lambası	14
		Merdiven aydınlatma lambası ve 360° dönebilen lamba	15
		Enerji verimliliği	16
		Yeni hareket dedektörü	17
		Otel çözümleri	18
		LIVINGLIGHT uygulama şekilleri	20
		Yeni alçıpan buatlar	22
		Kurulum sistemi - Geçmeli, Dikdörtgen	23
		Kurulum sistemi - Geçmeli, Air	24
		Kurulum sistemi - Modüler	26
		Kurulum sistemi - Modüler, Air	28
		LIVINGLIGHT montaj çözümleri	30
31-50	Katalog	LIVINGLIGHT mekanizma ve aksesuarlar	31-50
51-76	Çerçeveler ve kurulum	Geçmeli kurulum	52
		Modüler kurulum	63
		Kişiselleştirilebilir aydınlatma noktası	72
		Sıva üstü uygulama	73
		IP55 ve IP40 uygulama	74
77-80	Boyutlar		

# LIVING-LIGHT

## TEK SERİDE

### ÜÇ AYRI MEKANİZMA RENGİ

beyaz, alüminyum, antrasit

### ÜÇ FARKLI ÇERÇEVE MODELİ

Air, Dikdörtgen, Living International

## VE SAYISIZ KOMBİNASYON

## OLANAĞI



AIR ÇERÇEVE



DİKDÖRTGEN ÇERÇEVE





LIVING INTERNATIONAL ÇERÇEVE

DİKDÖRTGEN ÇERÇEVE

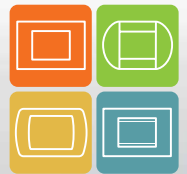

**Livinglight**

# AIR

Kusursuzluğun  
zarif  
eseri

Zarafet ve teknoloji,  
bir LIVINGLIGHT yeniliđi olan  
AIR'in kusursuz tasarımında  
bir araya geldi.  
5mm'den ince tasarımı ve  
şık görünümü ile LIVINGLIGHT  
AIR,LIVINGLIGHT inovasyonunun  
tasarımdaki zirvesi.



Yeni çerçeveler: YUMUŞAK (SOFT)



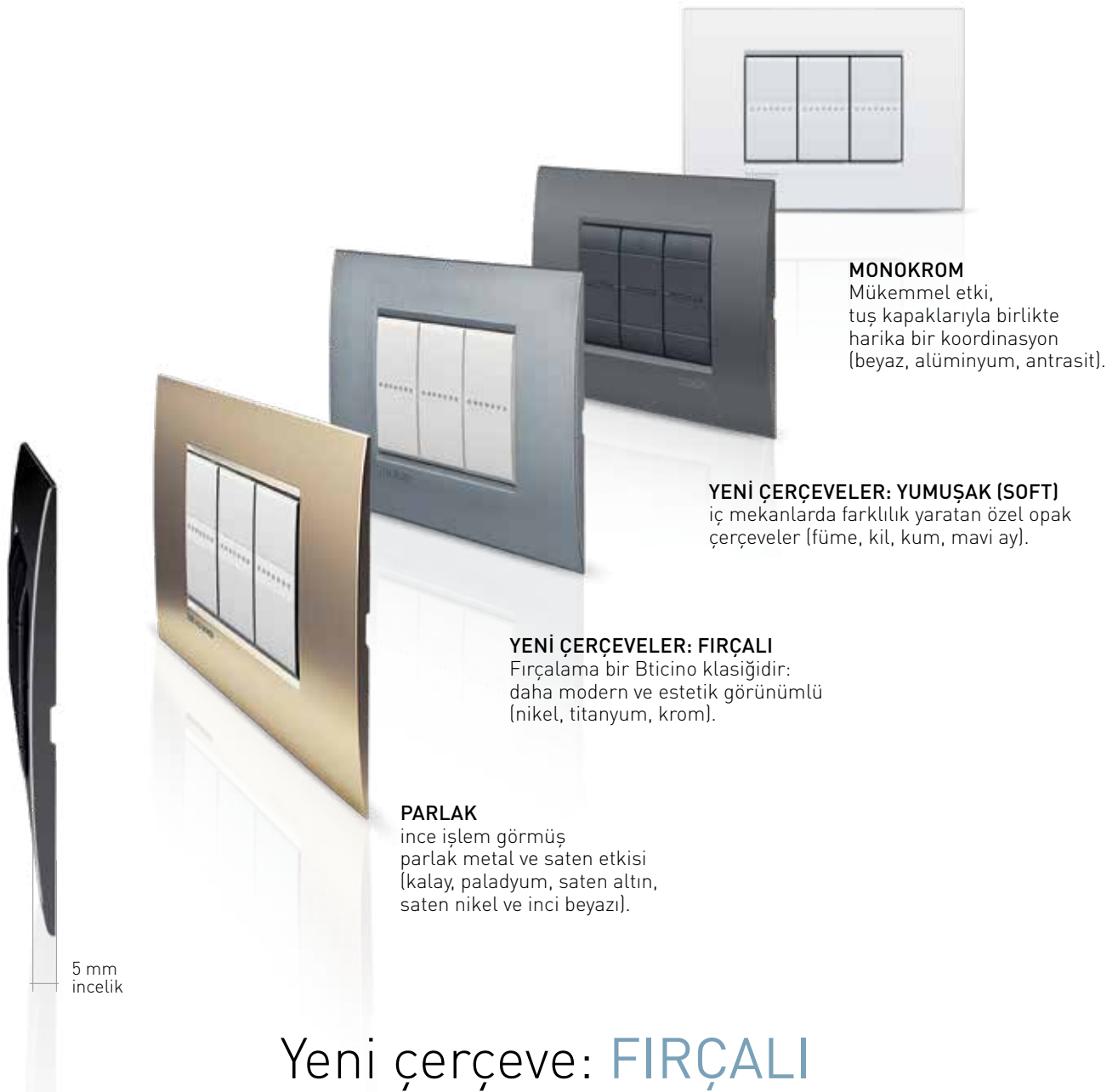

**MONOKROM**  
Mükemmel etki,  
tuş kapaklarıyla birlikte  
harika bir koordinasyon  
(beyaz, alüminyum, antrasit).

**YENİ ÇERÇEVELER: YUMUŞAK (SOFT)**  
iç mekanlarda farklılık yaratan özel opak  
çerçeveler (füme, kil, kum, mavi ay).

**YENİ ÇERÇEVELER: FIRÇALI**  
Fırçalama bir Bticino klasiğidir:  
daha modern ve estetik görünümlü  
(nikel, titanyum, krom).

**PARLAK**  
ince işlem görmüş  
parlak metal ve saten etkisi  
(kalay, paladyum, saten altın,  
saten nikel ve inci beyazı).

5 mm  
incelik

## Yeni çerçeve: **FIRÇALI**



FIRÇALI TİTANYUM

# DİKDÖRTGEN ÇERÇEVELER



## KRİSTAL

Tüm mekanizmalarla kolayca kullanılabilen zarif ve başarılı bir tasarım.

Yenilenen  
klasiklerin  
modası  
asla geçmez

Sadece gerçek klasikler onları eşsiz yapan tarzı koruyup aynı zamanda kendilerini yenileyebilirler.

LIVINGLIGHT dikdörtgen çerçeveler zamana karşı koyan tasarımı, etkileyici stili ve sunduğu işlevlerle klasikler arasında.



## NÖTR

Çerçeve ve mekanizma arasındaki muhteşem renk uyumu.



## AHŞAP

Doğa ve tasarıma ahşap serisinde buluşuyor: bambu, kiraz ağacı, ceviz ağacı.



## SAYDAM

Parlak renkler, büyüleyici tasarımlar.



## DOĞAL

Sadelığın vazgeçilmez etkileyiciliği.



## METAL

Modern yaşamın metal yansımaları



## İPEK

Hoş bir dokunuş için yumuşak ve canlı renkler.

# LIVING INTERNATIONAL

Vazgeçilmez  
Living International  
 **yeni**  çerçevelerle geri döndü.



Eşsiz LIVING INTERNATIONAL serisi ile İtalyan tasarımındaki mükemmelliği hissedeceksiniz.



**TAM BEYAZ - BI**  
Tertemiz, saf ve iddialı uyum.



**KROM - CT**  
Parlak ve göz alıcı etki.



**KOYU ÇELİK - AC**  
Güçlü ve etkileyici tasarım.



**ALTIN - OR**  
Işıldayan ahenk.



**BRONZ - BO**  
Keskin ve zarif dokunuş.



#### ANTRASİT TUŞ KAPAĞI

Sade ve zarif bir görünüm için pürüzsüz bir doku.

#### BEYAZ TUŞ KAPAĞI

İncecik satine dokusu sayesinde keyif verici ipeksi bir dokunuş. Tuş kapağı ise muhteşem ve daima TERTEMİZ bir görüntüye sahip.

#### ALÜMİNYUM TUŞ KAPAĞI

Daha teknolojik bir görünüm için beyaz anahtarın stili teknolojinin rengiyle buluştu.

# MEKANİZMA TASARIMLARI

Teknoloji  
tasarımla  
buluşuyor

LIVINGLIGHT'ın kontrol mekanizmaları yenilendi. Güzel ve fonksiyonel tuş kapakları, tüm modelleri ışıklandırabilmek için

LED ışıkları ve yepyeni mekanizması ile LIVINGLIGHT her türlü ihtiyaca çözüm sunuyor.



#### AXIAL KONTROLLER: BİR BTICINO YENİLİĞİ

BTicino standart kontrollere alternatif olarak Axial kontrol sistemlerini sunuyor. Axial kontrollere, yeni AIR çerçevelerin düzlemselliğini artırmak için ideal bir çözüm. Üst düzey elektromekanik teknoloji sonucunda yaratılan sessiz ve güvenilir bir kontrol.



#### STANDART KONTROLLER: SÜREKLİLİK VE YENİLEME

Maksimum düzeyde pratiklik için; daha iyi bir performans ve daha iyi bir görünüş.



Işıklar 

#### TÜM SERİDE LED AYDINLATMA

Tüm kontrollerde, göz yormayan zarif aydınlatmalar bulunur. BTicino enerji tasarrufu ilkelerine paralel olarak seçilen LED teknolojisi tüketimde önemli bir düşüş sağlar.



# YENİ NESİL ELEKTROMEKANİK MEKANİZMALAR

Daha iyi  
performans  
için tamamen  
yenilendi

**DAHA ÇEVRE DOSTU BİR  
YAKLAŞIMLA BTICINO,  
YENİ NESİL STANDART VE AXIAL  
MEKANİZMALARINI YARATTI**

Eko-sürdürülebilirlik sürecinden geçerek ortaya çıkarılan bu inovasyon, enerji tasarrufu ve hammadde tasarrufunu aynı anda sağlamaktadır.



Daha iyi bir mekanik güç için yeni kablo sıkma sistemi.

Mekanik hareketlerin mutlak duyarlılığı ile yeni patentli kontak sistemi.

Daha dayanıklı, yeni monoblok gövde.

## Alternatif çözüm Axial mekanizma

Bir BTicino yeniliği: Axial mekanizma; tuş kapakları ile kontrol (AÇIK/KAPALI)



# OTOMATİK BAĞLANTILI MEKANİZMALAR

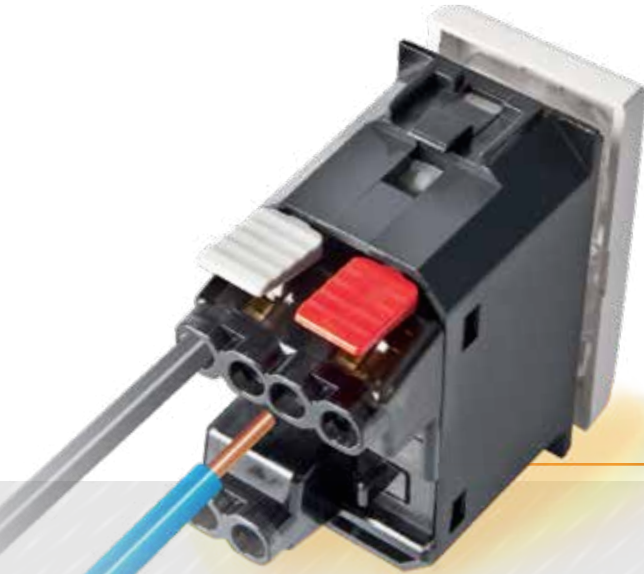

Kabartılmış kablo sıyırma işareti

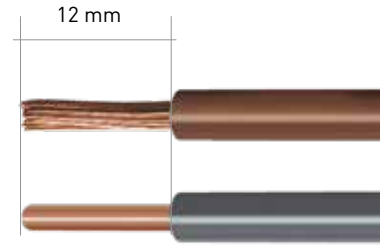

Kablo sıyırma 12 mm

**HIZLI**  
Kablolama için yalnızca birkaç saniye yeterli

**GÜVENİLİR&DAYANIKLI**  
Zamana karşı dayanıklı kablolama

Yüksek düzeyde çözümler sunan BTicino için her ayrıntı önemlidir.



**KOLAY**  
Hiçbir özel alet gerektirmez.



**ESNEK**  
Kabloları farklı bölümlerde de kullanabilme olanağı.

	STANDART ANAHTARLAR		AXIAL ANAHTARLAR	
	1 modül	2 modül	1 modül	2 modül
ANAHTAR	<input checked="" type="checkbox"/>	<input checked="" type="checkbox"/>	<input checked="" type="checkbox"/>	<input checked="" type="checkbox"/>
VAVİEN	<input checked="" type="checkbox"/>	<input checked="" type="checkbox"/>	<input checked="" type="checkbox"/>	<input checked="" type="checkbox"/>
PERMÜTATÖR	<input type="checkbox"/>	<input type="checkbox"/>	<input type="checkbox"/>	<input type="checkbox"/>
LIHT BUTONU	<input checked="" type="checkbox"/>	<input checked="" type="checkbox"/>	<input checked="" type="checkbox"/>	<input checked="" type="checkbox"/>

Otomatik bağlantılı mekanizmalar  Vida bağlantılı mekanizmalar



# Yeni AXIAL ANAHTAR

**İNDİRGENMİŞ** derinlik  
**ÜSTÜN** ergonomi



## MÜKEMMEL İNCELİK.

Yeni Axial anahtarlar daha az yer kaplıyor: **eskiye göre %30 daha ince**

- **kolay kurulum:** yeni sistemlerde veya yenileme projelerinde kolaylık.
- çerçeveler ve Living Light AIR kaideler ile mükemmel uyum.

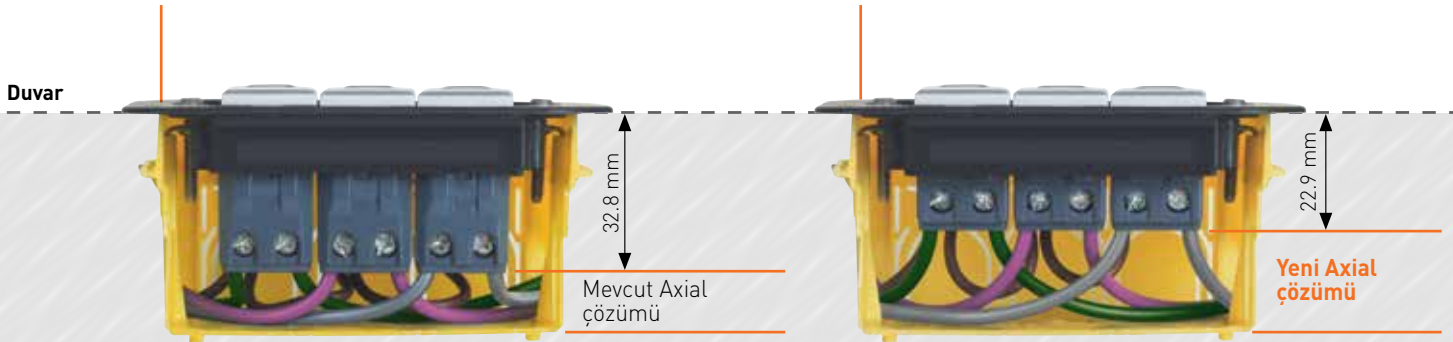

## ERGONOMİK

Yeni Axial anahtarların hassasiyeti elektronik anahtarlar gibi yumuşaktır.

- **Düşük açıklık:** eskisine göre **%35** (3.5mm yerine 2.2mm)
- **Düşük itme kuvveti:** **%40** daha hassas basma sağlar (9N yerine 5N kuvvet)
- **%18** daha sessiz
- **Yeni LED'ler ile** arka aydınlatma



# DİMMER: ...HER ÇEŞİT YÜKÜN VERİMLİ YÖNETİMİ



## ÜNİVERSAL DİMMERLER

BTicino üniversal dimmerler ile her çeşit dimlenebilir yükün kontrol edilmesi ve aydınlık seviyesinin ayarlanması mümkündür.

## KURULUM AVANTAJLARI:

- Farklı türdeki yüklerin kontrol edilebilmesi sayesinde yük seçilmeden önce kurulum yapılabilir.
- 2 kablo ile (nötr yoktur) hızlı montaj yapılabilir.
- Var olan bir dimmerin yerine kolayca takılabilir.
- 1 veya daha fazla liht butonu ile uzaktan kumanda edilebilir.

## ERGONOMİ'NİN İKİ HALİ.



## ROTATİF DİMMER

Çevirmeli dimmerlerde geniş ürün yelpazesi ile 1 ya da 2 modül çözüm sunar.



## DOKUNMATİK DİMMER

Basit bir dokunuş ile açma-kapama ve parlaklık ayarı kolaylığı sunar

DİMMER TİPLERİ	Enerji tasarruflu lamba halojen enerji tasarruflu	Halojen elektronik trafolu	Halojen mekanik trafolu	Halojen 230V	Akkor flamanlı 230 V	Dimlenebilir kompakt floresan	Dimlenebilir LED	Balastlı floresan lamba 0-10 V
REZİTİF	<input checked="" type="checkbox"/>	<input type="checkbox"/>	<input type="checkbox"/>	<input checked="" type="checkbox"/>	<input checked="" type="checkbox"/>	<input type="checkbox"/>	<input type="checkbox"/>	<input type="checkbox"/>
REZİTİF-ENDÜKTİF	<input checked="" type="checkbox"/>	<input type="checkbox"/>	<input checked="" type="checkbox"/>	<input checked="" type="checkbox"/>	<input checked="" type="checkbox"/>	<input type="checkbox"/>	<input type="checkbox"/>	<input type="checkbox"/>
BALAST 0-10V	<input type="checkbox"/>	<input type="checkbox"/>	<input type="checkbox"/>	<input type="checkbox"/>	<input type="checkbox"/>	<input type="checkbox"/>	<input type="checkbox"/>	<input checked="" type="checkbox"/>
ÜNİVERSAL	<input checked="" type="checkbox"/>	<input checked="" type="checkbox"/>	<input checked="" type="checkbox"/>	<input checked="" type="checkbox"/>	<input checked="" type="checkbox"/>	<input checked="" type="checkbox"/>	<input checked="" type="checkbox"/>	<input type="checkbox"/>

# DİMLENEBİLEN MOBİL LAMBALAR



Konfor ve  
güvenlik  
bir arada

2 MODÜL LIVINGLIGHT AIR  
ÇERÇEVE + LAMBA

## MODERN, TEKNOLOJİK.

Yeni mobil lambalar, karanlıkta ihtiyacınız olan güvenliği garanti eder. BTicino anahtar-priz ürün grupları ile mükemmel uyumu olan bir tasarımdır. Bastır/çek çıkart sistemi ile istediğiniz zaman el fenerine dönüştürebilirsiniz.

BASTIR



ÇEK



## BASTIR-ÇEK SİSTEMİ VE LED IŞIK

Sıva altı çerçeve içinden çıkarılabilen ergonomiye sahiptir. LED ışık sayesinde, ışık şiddeti ayarlanabilir, az elektrik tüketimi ile daha iyi performans sunar.

## TEK REFERANS İLE ÇÖZÜM

Taban + 3 farklı renkte ön kapak + el feneri= tek referans ile kolayca sipariş edilebilir.

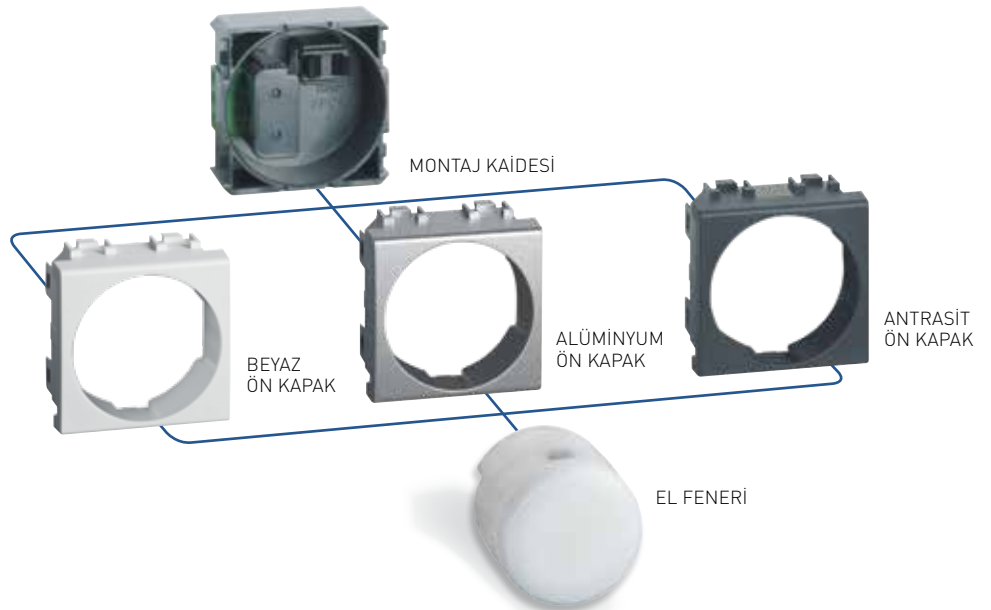

# DİMLENEBİLEN OKUMA LAMBASI

Yeni LED aydınlatma konut ve diğer yaşam alanlarında konfor ve güvenliğe katkı yaparak konforlu ortamlar oluşturmak için yaratıldı.



## Dimlenebilen OKUMA LAMBASI

### Rahatlığınız için ideal aydınlatma

BTicino'nun yeni okuma lambasıyla aydınlatmak istediğiniz yeri seçebilirsiniz. Esnek ve hareketli kordon ile LED aydınlatmasına yön verebilirsiniz.



DİMLENEBİLEN OKUMA LAMBASI

Aydınlatmaya adanmış ürün grupları ile merdiven aydınlatmasından, okuma lambasına, **BTicino Ev Aydınlatma** ürünleri evde yaşayan herkese orjinal, güvenli, fonksiyonel bir ortam sunar.



## Merdiven aydınlatma LAMBASI

### Yeni, yönlü merdiven aydınlatma.

Daha bugünden evinizin aydınlatma tasarımında yer almaya aday: Yeni, yönlü LED lamba ile güvenli ve konforlu bir ortam yaratın. Özellikle geçiş noktalarında, koridor ve merdivenlerde ya da karanlık gece vakitlerinde ihtiyacınız olan doğru aydınlatmayı garanti eder.



MERDİVEN AYDINLATMA LAMBASI

## 360° dönebilen LAMBA

### Nereyi isterseniz sadece orayı aydınlatın.

İhtiyaç duyulan bölgeyi etkili biçimde 360°'lik açıyla aydınlatmak üzere geliştirilmiştir. Özellikle çalışma yüzeylerinin (örn. ocak, çalışma masası vb.) aydınlatılması için şık ve kullanışlı bir çözüm sunar. Normal bir lambanın yönetimi gibi standart bir kumanda kullanılarak yönetilebilir.



DÖNEBİLEN (AYARLANABİLEN) LAMBA



# ENERJİ VERİMLİLİĞİ



Yeni yönetmeliklere uygun çevre ve binaların enerji sertifikasyonlarıyla, modernizasyonundan ve konfordan ödün vermeye gerek yok.

**Işık çıkış paritesi daha düşük tüketim**

## MAKSİMUM VERİM İLE IŞIK AYARI

Yeni universal dimmer ile kompakt floresan lambalarda LED kadar güç tüketerek %65 oranında tasarruf sağlayabilirsiniz.



TERMOSTAT



## NE ZAMAN, NEREYİ İSTERSENİZ ISITIN VEYA SOĞUTUN

BTicino termostatlar ile (MyHOME yerine klasik olan ile):

- her oda için ayrı iklimlendirme yapabilir,
- bir bölgeyi farklı parçalara bölerek kontrol edebilirsiniz.



DOKUNMATİK EKRANDA TÜKETİM MİKTARINI GÖRÜNTÜLEME OLANAĞI



## TÜM ENERJİ TÜKETİM VE ÜRETİMİNİN KONTROLÜ

Evin tüm tüketimini görüntüleme - elektrik, su ve doğalgaz - sıcak su ve enerji üretimi, fotovoltaik ya da güneş enerjisi ile üretilen enerjiyi görüntüleyerek gereksiz kullanımı önleyebilirsiniz.

**MyHOME**  
Otomasyon



## HAREKET DEDEKTÖRÜ: YALNIZCA GEREKLİ OLDUĞUNDA AYDINLATIR

Hareket dedektörü konut ve diğer yaşam alanlarında aydınlatma atığı olmadan sunulan akıllı ve öncü çözümlerdir. Aydınlatma kullanıldığında devreye girer ve alanda kimse olmadığında otomatik olarak söner



Pasif kızılötesi hareket dedektörü - Otomatik model



iki teknoloji hareket dedektörü  
- Kızılötesi ve ultrasonik  
- EKO MODELİ  
- OTO MODELİ

# YENİ HAREKET DEDEKTÖRÜ













ENERJİ TASARRUFU İÇİN İDEAL



HAREKET DEDEKTÖRÜ

## Yenilikçilik ve akıllı kontrol:

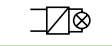
Normal bir anahtar gibi yönetilen yükün manuel olarak açılıp kapatılmasını sağlamanın yanı sıra ışığın açık kalması durumunda otomatik olarak kapatabilir. 10 dakika boyunca herhangi bir hareket tespit edilmezse, anahtar bağlı olduğu yükü devre dışı bırakır. Nötr hattına ihtiyacı yoktur ve ışıklar kapalıyken tüketim sıfırdır.

		R		E		K/E		
		 Akkor flamanlı 230V	 Halojen 230V	 ELV Halojen ferromanyetik transformatörlü	 Halojen elektronik transformatörlü	 Floresan lambalı	 Led	 Kompakt floresan lambalı
								
230V ~	Maks.	150 W	150 W	150 VA	150 VA	100 VA	650 mA	650 mA
	Min.	12 W	12 W	12 VA	12 VA	12 VA	50 mA	50 mA

# OTEL'DE EVDE GİBİ



**YENİ**

**KAPI DIŞI ÜNİTESİ:** "DO NOT DISTURB"  
- "MAKE UP ROOM" SEÇENEKLİ UYARICI  
LAMBA, KAPI ZİLİ VE KART OKUYUCU



**ODA İÇİNDE:** "DO NOT DISTURB" - "MAKE UP THE ROOM"  
UYARI DÜĞMELERİ, KART OKUYUCU



**MyHOME**  
Otomasyon



## Müşteri ihtiyaçlarına maksimum özen: Ulaşılabilir servis, rahatlık, kolay kullanımlı ürünler



TIRAŞ PRİZİ



**YENİ**

DİJİTAL TERMOSTAT,  
MYHOME



**YENİ**

8 ANAHTARLI MYHOME  
KONTROL

### GÜVENLİK İÇİN EKSTRA ÖZEN

Gece için basamak uyarıcı ışık.  
Acil durum ipi ile sürekli maksimum güvenlik.

### TEK HAREKET İLE MÜKEMMEL ATMOSFER

Yeni MyHOME dijital termostat ve 8 anahtarlı kontrol mekanizması ile tek dokunuşta en doğru ısı ve ışık ayarı.

# MyHOME

Otomasyon



TÜM ELEKTRONİK ALETLERİNİZ İÇİN  
HDMI VE USB BAĞLANTISI.



STOR PERDE, YATAK BAŞLIĞI VE  
BAŞUCU LAMBASI KONTROLÜ

**Otel odaları da dahil olmak üzere tüm elektrik sistemleri için komple çözüm.**

### BAĞLANTI, EĞLENCE VE MULTİMEDYA

Audio/Video bağlantıları için üst düzey rahatlık ve eğlence sağlar.

### ANINDA TANIMLANABİLİR FONKSİYONLAR

Arkadan ışıklı yapısı, kolay anlaşılır sembolleriyle her fonksiyon rahatlıkla tanımlanabilir.

# LIVINGLIGHT UYGULAMA ŐEKİLLERİ

## Geçmeli uygulama

MERKEZLER ARASI MESAFE: 71 mm



2 MODÜL

- Dikey ve yatay kurulumuna uyumlu dikdörtgen çerçeveler



2 + 2 MODÜL



2 + 2 + 2 MODÜL



2 + 2 + 2 + 2 MODÜL

# Modüler uygulama



2 MODÜL



3 MODÜL



4 MODÜL





7 MODÜL



3 + 3 MODÜL

## UYGULAMA ŞEKİLLERİ

	Modüler					Standart 71 mm		
	2	3	4	7	3+3	2+2	2+2+2	2+2+2+2
 DİKDÖRTGEN	■	■	■	■	■	■	■	■
 LIVING INTERNATIONAL	■	■	■	■	■	□	□	□
 AIR	■	■	■	■	■	■	■	□



Uygun



Uygun değil

# YENİ ALÇIPAN BUATLAR

Kolay, hızlı, profesyonel



**MÜKEMMEL KURULUM İÇİN  
MERKEZ ODAKLAMA**



**ALETSİZ AÇMA**

Elle kapakçıkları açabilir ve kablolamayı rahatlıkla yapabilirsiniz.



**ÜÇLÜ KAVRAMA**

Güçlendirilmiş geniş flanş, metal kelepçeler ve lastik şeritler ile montaj şimdi daha da güvenli.



**ESNEK, SAĞLAM GÖVDE**

Hava geçirmez membranlar ile tüm kanallar elastik yapı sayesinde rahatlıkla buatla bütünleşir ve hava akımı oluşturmaz.



**KOLAY MONTAJ VE  
DEMONTAJ**

Uygun montaj yapıldığında kolaylıkla demonte olur ve tekrar kullanılabilir.



**GİZLİ İYİLEŞTİRMELER**

ince ama geniş kulakçıklar ile mükemmel tutunma

ESKİ BUATLAR  
100 m<sup>3</sup>/h



YENİ BUATLAR  
4 m<sup>3</sup>/h



## ÖZELLİKLER

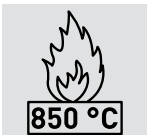

**Alev iletmez**

EN60670 Standardına göre 850°C'ye kadar alev iletmez.



**Sağlam**

Propilen malzemeden üretilmiştir ve güvenilir bir yapıya sahiptir.



**Toza karşı koruma**

IP40 Koruma sınıfında, hem kullanım hem de montaj esnasında plastik membran sayesinde toz geçişi en aza indirgenmiştir.

# DİKDÖRTGEN KURULUM SİSTEMİ: GEÇMELİ

Standart sıva altı buatlar

## LIVING-LIGHT

normal sıva altı buatlar ve 2 modül kaideler ile kullanılabilir ve kullanıcının zevkine göre dikdörtgen çerçeveler ile tamamlanabilir.

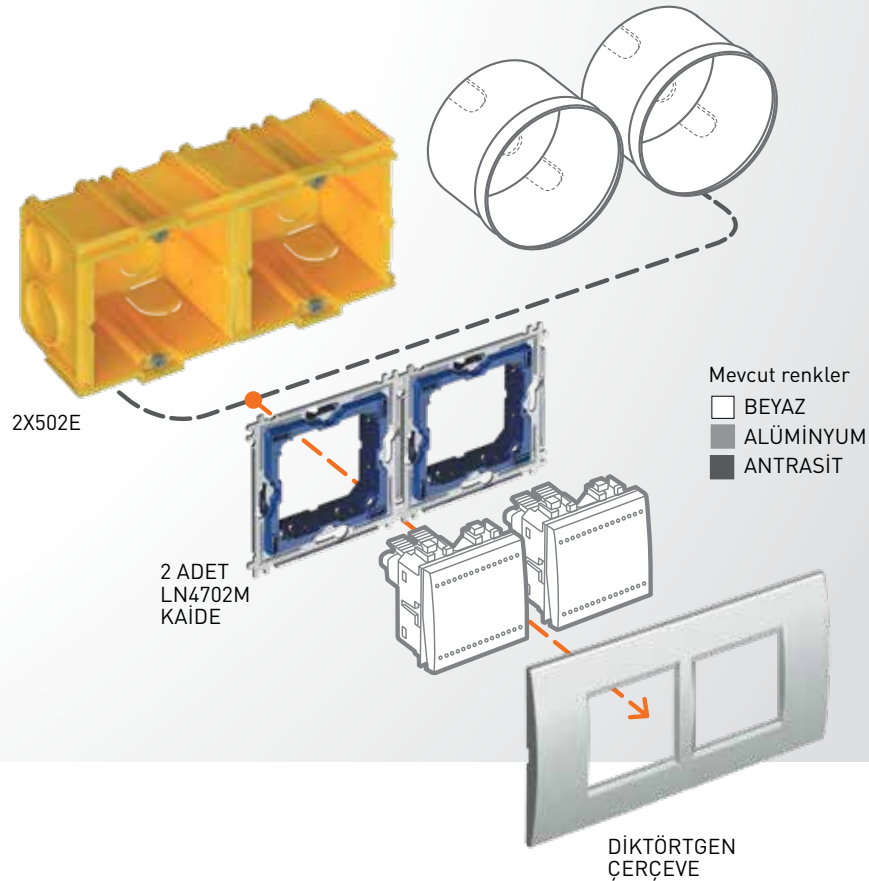
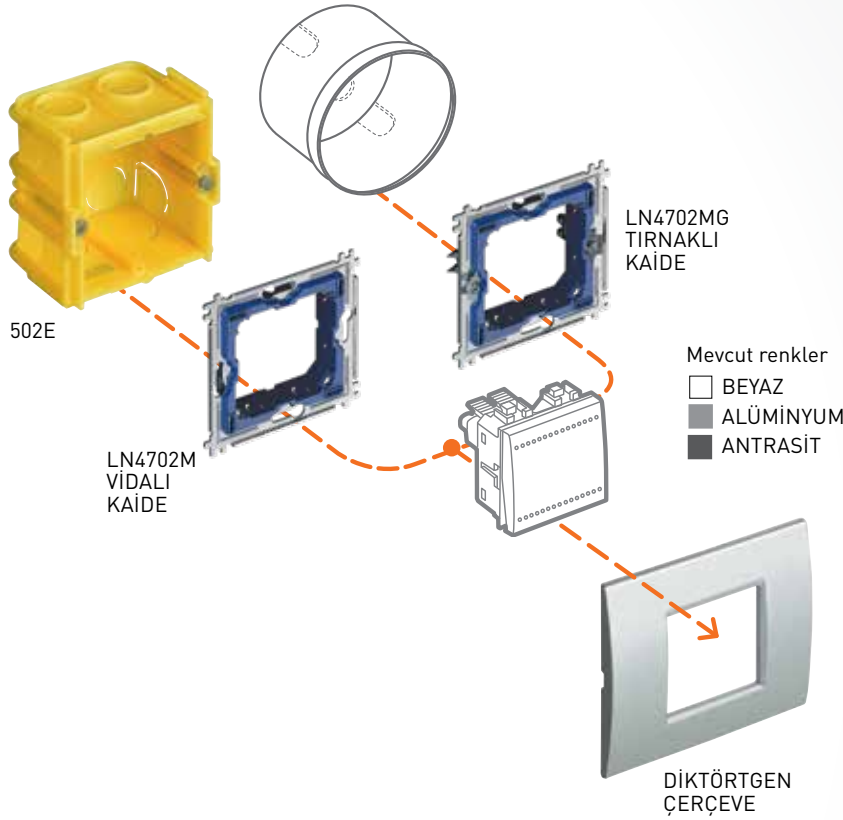

# AIR KURULUM SİSTEMİ: GEÇMELİ

## 2 MODÜL

502E  
ÖRME DUVARLAR  
İÇİN VIDALI BUAT



PB502N  
ALÇIPAN  
DUVARLAR İÇİN  
VIDALI BUAT

LN4702E  
AIR 2 MODÜL KURULUMLAR İÇİN  
ÖZEL KAİDE

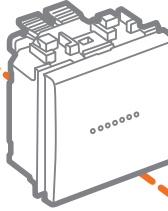

Mevcut renkler  
□ BEYAZ  
■ ALÜMİNYUM  
■ ANTRASİT

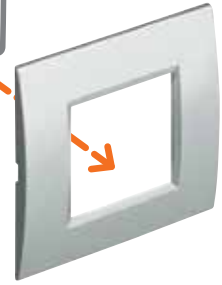

2 X PB502N  
PB502A İLE BAĞLANTI



PB502A  
BAĞLANTI AKSESUARİ

## 2 + 2MODÜL

2 x 502E  
GEÇMELİ BAĞLANTI

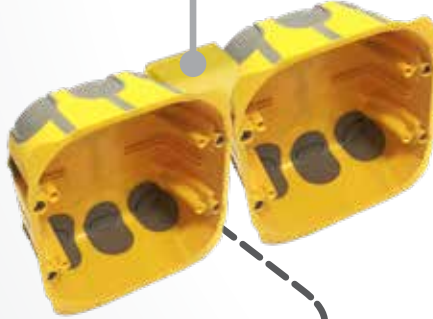
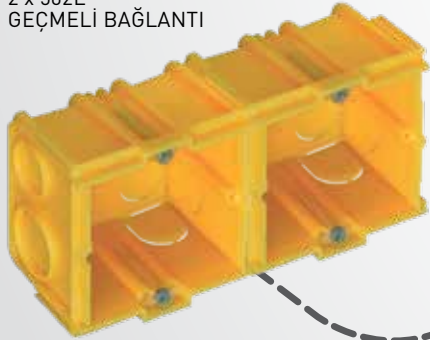

2 x LN4702E  
GEÇMELİ BAĞLANTI

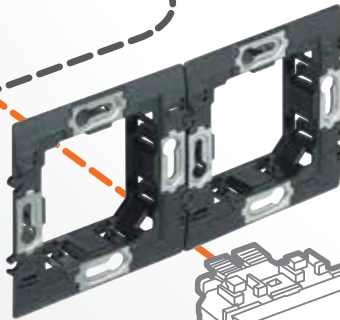

Mevcut renkler  
□ BEYAZ  
■ ALÜMİNYUM  
■ ANTRASİT

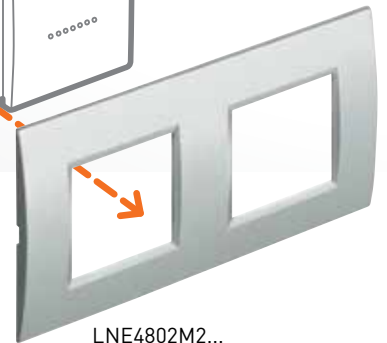
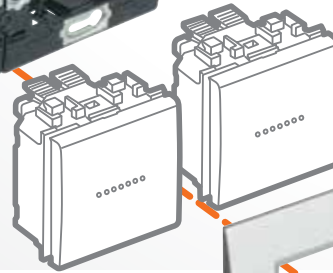

**NOT:** YATAY VEYA DİKEY  
KURULUM

LNE4802M2...  
2 MODÜL KURULUM İÇİN  
AIR ÇERÇEVE



## 2 + 2 + 2 MODÜL

3 x 502E

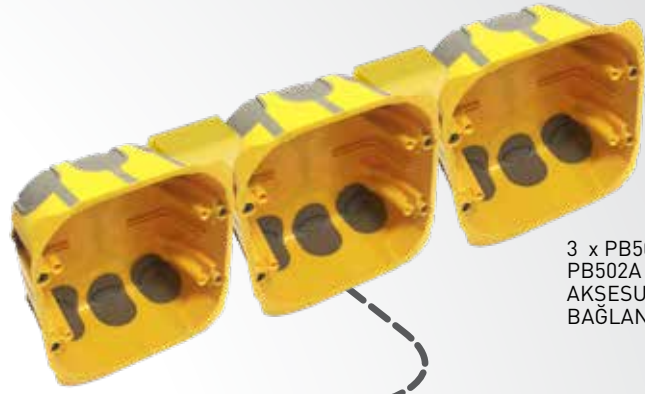
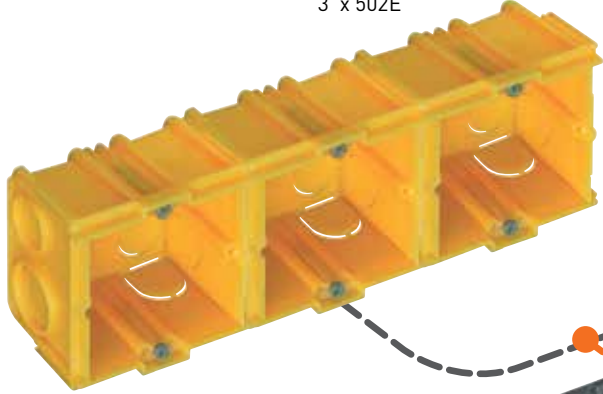

3 x PB502N  
PB502A BAĞLANTI  
AKSESUARİ İLE  
BAĞLANABİLİR

3 x LN4702E

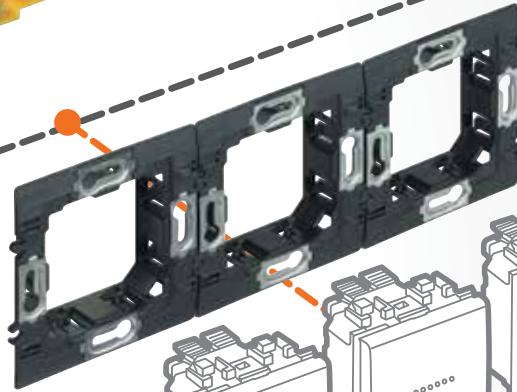

Mevcut renkler  
□ BEYAZ  
■ ALÜMİNYUM  
■ ANTRASİT

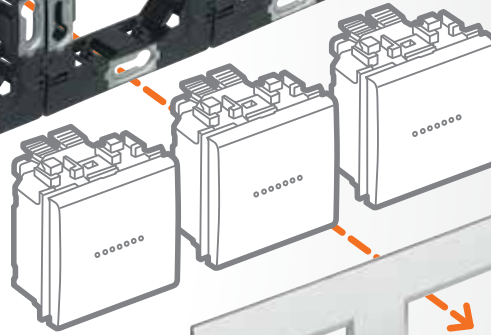

**NOT:** YATAY VEYA DİKEY  
KURULUM

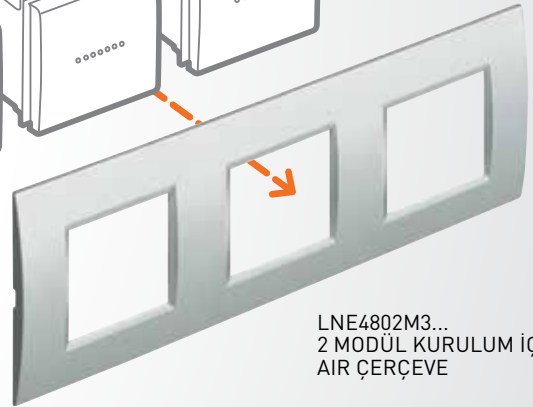

LNE4802M3...  
2 MODÜL KURULUM İÇİN  
AIR ÇERÇEVE

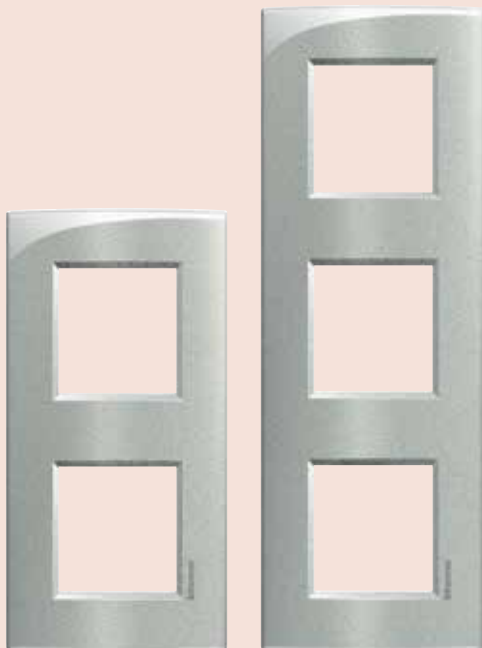

## LIVINGLIGHT<sup>AIR</sup>

LIVINGLIGHT AIR ile duvarlardaki çerçeve ve kaideler daha zarif bir görünüm sunar.

- 2 modül kurulum:  
BTicino buat 502E ve PB502 Kurulum, buatlara özel kaideler ve çerçevelerle tamamlanır.

### Öneriler:

- Örme duvarlarda daha rahat kurulum için buat genişletici aksesuar kullanılması tavsiye edilir.



5mm'den  
az

# AIR, DİK DÖRTGEN, LIVING INTERNATIONAL MONTAJ SİSTEMLERİ: MODÜLER

Standart sıva altı  
buat

PB503N ALÇIPAN BUAT



503E ÖRME DUVAR BUAT



LIVINGLIHT KAİDE LN47...  
(Örn.: LN4703 = 3 MODÜL)

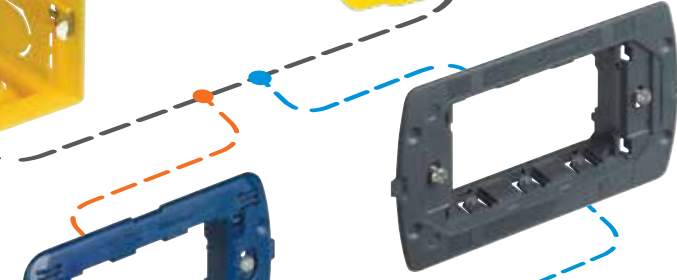

YENİ LIVINGLIHT AIR KAİDE LN47..C  
(Örn.: LN4703C = 3 MODÜL)

Mevcut renkler  
□ BEYAZ  
■ ALÜMİNYUM  
■ ANTRASİT

ORTAK  
MEKANİZMALAR

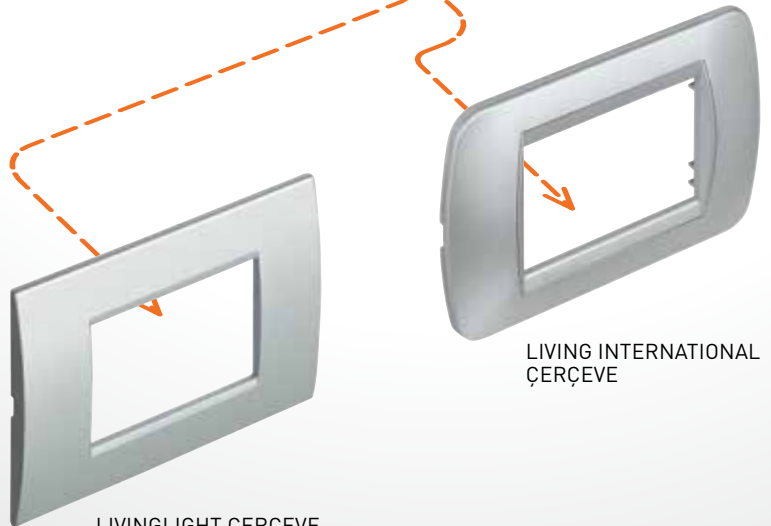

LIVINGLIHT ÇERÇEVE  
(DİK DÖRTGEN)

LIVING INTERNATIONAL  
ÇERÇEVE



## LIVINGLIGHT

LIVINGLIGHT normal sıva altı buatlar ve 2, 3, 4, 7 ve 3+3 modül kaideler ile kullanılabilir ve kullanıcının zevkine göre dikörtgen çerçevelerle tamamlanabilir.

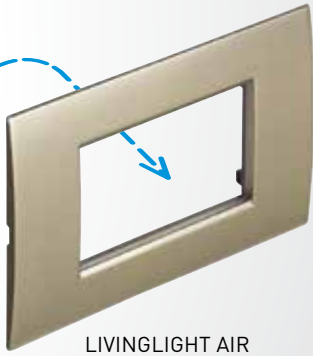

LIVINGLIGHT AIR  
ÇERÇEVE

## BUAT GENİŞLETME AKSESUARİ: MEKANİZMANIN GİRECEĞİ ALANIN DERİNLİĞİNİ ARTTIRMAK İÇİN BTICİNO BUATLARI İLE KULLANILABİLİR.

Sıva altı montajlarda kurulumu hızlandırmak ve kolaylaştırmak için üretilen bu adaptör ile beton duvarlarda montaj derinliği artırılır. 3, 4, 7 ve 3+3 modüller için de uyumlu olan bu adaptör, aynı buat içindeki fazla kabloların sonlandırılmasında kolaylık sağlar.

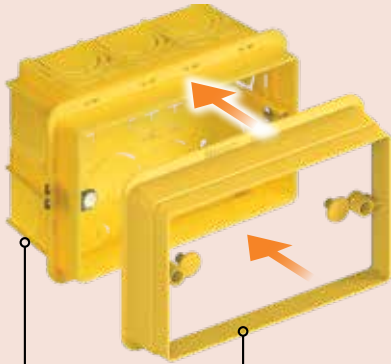

503E BUAT

503ESE  
BUAT GENİŞLETME AKSESUARİ  
(derinlik adaptörü)

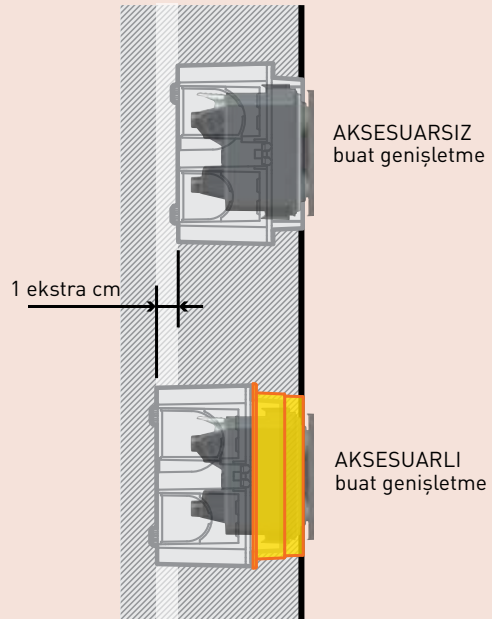

AKSESUARSIZ  
buat genişletme

AKSESUARLI  
buat genişletme

# AIR MONTAJ SİSTEMİ: MODÜLER

## TEKNOLOJİ VE STİLİN MÜKEMMEL BULUŞMASI

Maksimum düzlemsellik için yepyeni incecik çerçeveler. Modern sadeliğin resmedilmiş hali.

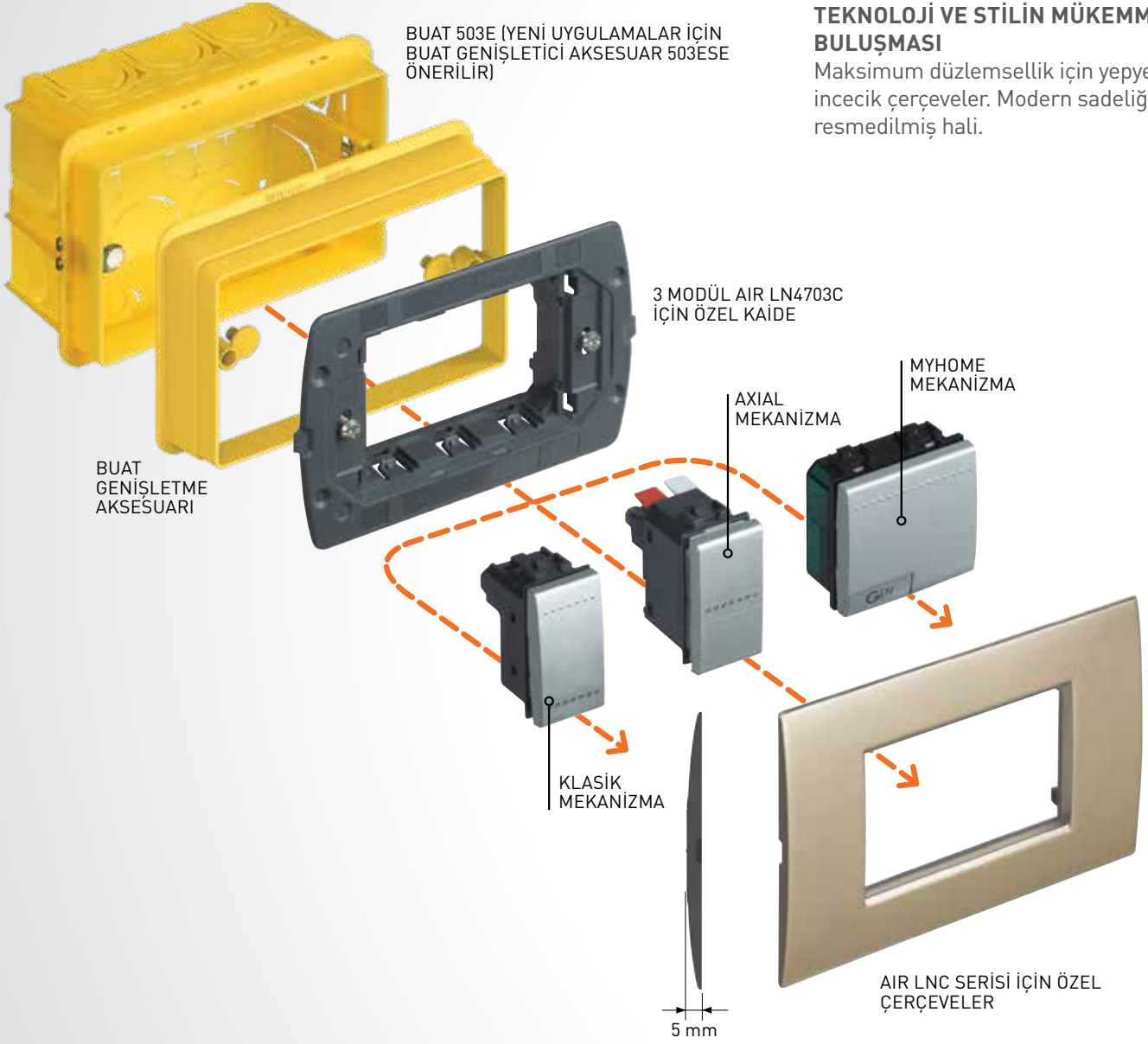

## Özel Air kaideler

Daha ince tasarlanmış, güçlendirilmiş, esnek ve dayanıklı plastik kaide.



Cihazınızı toz, boya, çizik gibi etkilerden korumak için ideal çözüm sunan koruma kılıfları.



Geri dönüştürülebilir çevre dostu plastik.

### KURULUM ÖNERİLERİ

Kablolama öncesi kutu içi temiz olmalıdır. \*



Mekanizmayı resimdeki gibi dışarıya doğru sarkıtmayınız.



Koruma kılıfları, mekanizmayı her türlü dış etkiden korumak için tasarlanmıştır.



Tüm iş bittikten sonra, koruma kılıfını atıp, çerçeveyi monte edebilirsiniz.



\* Gerekirse, buat genişletme aksesuarı (503ESE), kullanarak, buat içinde daha geniş bir alan yaratabilirsiniz.

## ÖRME DUVAR - SIVA ALTI UYGULAMA

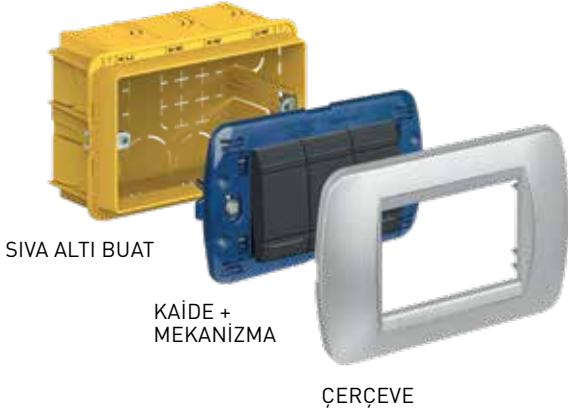

## ALÇIPAN - SIVA ALTI UYGULAMA

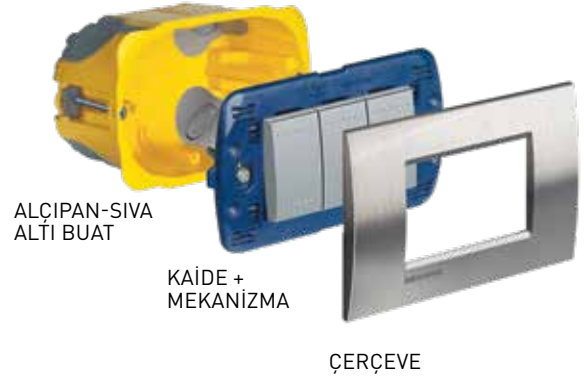

# LIVINGLIGHT MONTAJ ÇÖZÜMLERİ

## SIVA ÜSTÜ MONTAJ ÇÖZÜMLERİ

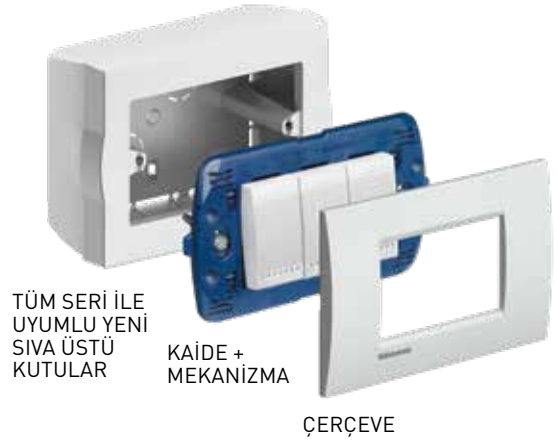

## IP40 - IP55 UYGULAMALAR

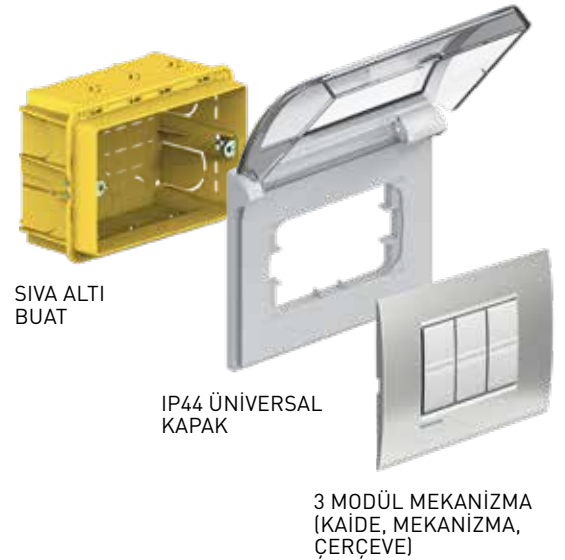
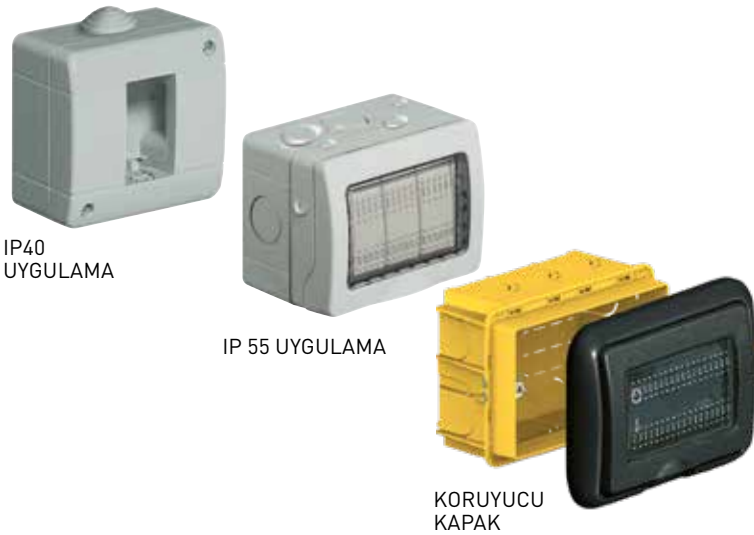

**Not:** Montaj çözümleriyle ilgili tüm detayları ve ürün kodlarını katalogdaki ilgili bölümde bulabilirsiniz.



# KATALOG

# TEMEL KONTROL MEKANİZMALARI

## STANDART ANAHTAR



N4001A



N4001M2A



NT4001A



NT4001M2A



L4001A



L4001M2A



LN4001A

		ANAHTAR MEKANİZMALARI	
		1 modül	2 modül
Tanım	Renk	Ref.	Ref.
ANAHTAR 1 KUTUP 16 AX 250 V AC.	<input type="checkbox"/>	N4001A	N4001M2A
	<input type="checkbox"/>	NT4001A	NT4001M2A
	<input type="checkbox"/>	L4001A	L4001M2A
	<input type="checkbox"/>	LN4001A	-
VAVİEN 1 KUTUP 16AX 250V AC.	<input type="checkbox"/>	N4003A	N4003M2A
	<input type="checkbox"/>	NT4003A	NT4003M2A
	<input type="checkbox"/>	L4003A	L4003M2A
	<input type="checkbox"/>	LN4003A	-
PERMÜTATÖR 1 KUTUP 16AX 250V AC.	<input type="checkbox"/>	N4004N	N4004M2N
	<input type="checkbox"/>	NT4004N	NT4004M2N
	<input type="checkbox"/>	L4004N	L4004M2N
	<input type="checkbox"/>	LN4004N	-
LİHT BUTONU 1 KUTUP (NO) 10A 250 V AC.	<input type="checkbox"/>	N4005A	N4005M2A
	<input type="checkbox"/>	NT4005A	NT4005M2A
	<input type="checkbox"/>	L4005A	L4005M2A
	<input type="checkbox"/>	LN4005A	-

**Not:** ○ tuş kapağı olmadan satılır. İlerleyen sayfalarda listelenen tuş kapaklarıyla ya da diğer kontrol mekanizmalarının tuş kapaklarıyla tamamlanabilirler.

## AXIAL ANAHTAR



N4051AN



N4051M2AN



NT4051AN



NT4051M2AN



L4051AN



L4051M2AN

		ANAHTAR MEKANİZMALARI	
		1 modül	2 modül
Tanım	Renk	Ref.	Ref.
ANAHTAR 1 KUTUP 16 AX 250 V AC.	<input type="checkbox"/>	N4051AN	N4051M2AN
	<input type="checkbox"/>	NT4051AN	NT4051M2AN
	<input type="checkbox"/>	L4051AN	L4051M2AN
VAVİEN 1 KUTUP 16AX 250V AC.	<input type="checkbox"/>	N4053AN	N4053M2AN
	<input type="checkbox"/>	NT4053AN	NT4053M2AN
	<input type="checkbox"/>	L4053AN	L4053M2AN
PERMÜTATÖR 1 KUTUP 16AX 250V AC.	<input type="checkbox"/>	N4054	N4054M2
	<input type="checkbox"/>	NT4054	NT4054M2
	<input type="checkbox"/>	L4054	L4054M2
LİHT BUTONU 1 KUTUP (NO) 10A 250 V AC	<input type="checkbox"/>	N4055AN	N4055M2AN
	<input type="checkbox"/>	NT4055AN	NT4055M2AN
	<input type="checkbox"/>	L4055AN	L4055M2AN

**Not:** Axial anahtarlar ilerleyen sayfalarda listelenen Axial anahtar için tuş kapaklarıyla tamamlanabilirler.

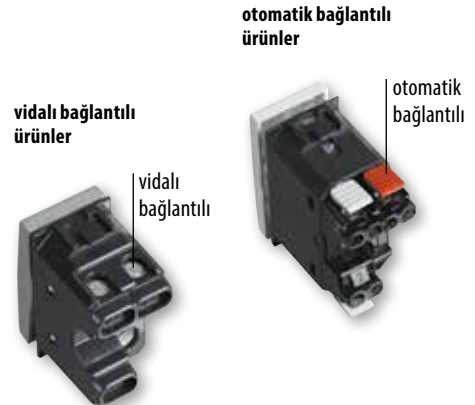



# ELEKTRİK KONTROL ÜRÜNLERİ

**N4003ES**

**NT4003ES**

**L4003ES**

Ref.



## HAREKET DEDEKTÖRLERİ

- N4003ES
- NT4003ES
- L4003ES



Varlık dedektörü içeren hareket dedektörü, normal bir VAVİEN gibi manuel olarak ON-OFF yapma imkanı sunmasının yanı sıra 10 dakika hareket algılamazsa otomatik olarak ışığı kapatır.

IR hareket dedektörü 8 metreye kadar 160°'lik alanı kapsar. Aynı hatta taşınabilen her yük tipi için kullanıma uygundur.

- 12-150W: halojen ve rezistif yükler

- 2-150VA: elektronik ya da ferromanyetik balastlı lambalar

- 8-30W (veya 650 mA): LED ve CFL

Özellikle ışığın uzun süre açık kalabileceği çocuk odası, garaj gibi alanlarda kullanılmak için uygundur.

Nötr hattına ihtiyaç yoktur, 127-230V, 2 modül.

## BAĞLANTI ŞEMASI



### N/NT/L4003ES

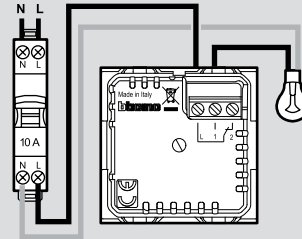

### Hareket dedektörü + Vavien

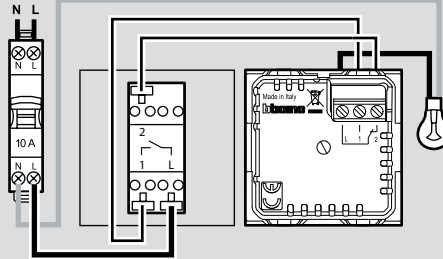

Vavien'in ya da dedektörün herhangi biri ışıkları açtığı anda IR dedektörü aktif hale gelir. Yüke yakın ya da uzak kurulabilir ve 10dk. boyunca hareket olmazsa devreyi açar.

### 2 Hareket dedektörü

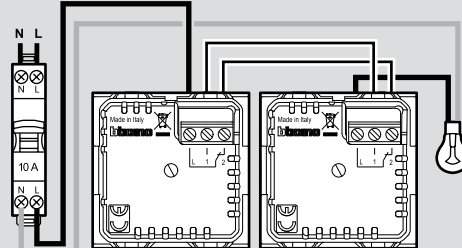

İşık açıkken 2 IR dedektörü deaktif olur. 10dk. boyunca hareket olmazsa ışık otomatik olarak kapanır.

# KLASİK ANAHTARLAR İÇİN TUŞ KAPAKLARI

## TEK FONKSİYON



		IŞIKLANDIRILABİLİR TUŞ KAPAKLARI		
		1 modül	2 modül	3 modül
Tanım		Ref.	Ref.	Ref.
ALT KISMI IŞIKLI, DEĞİŞTİRİLEBİLİR TUŞ KAPAĞI	<input type="checkbox"/>	N4915N	N4915M2N	N4915M3N
	<input type="checkbox"/>	NT4915N	NT4915M2N	NT4915M3N
	<input type="checkbox"/>	L4915N	L4915M2N	L4915M3N
YÜKSEK PARLAKLIĞA SAHİP TUŞ KAPAĞI	<input type="checkbox"/>	N4915LN	N4915M2LN	N4915M3LN

**Not:** değiştirilebilir tuş kapakları, tuş kapaksız temin edilen mekanizmalarla yapılan kurulumuna uygundur.



N4915N

NT4915N

L4915N



N4915LN

		IŞIKLANDIRILABİLİR SEMBOLLÜ TUŞ KAPAKLARI	
		1 modül	2 modül
Tanım		Ref.	Ref.
LAMBA SEMBOLLÜ	<input type="checkbox"/>	N4915AN	N4915M2AN
	<input type="checkbox"/>	NT4915AN	NT4915M2AN
	<input type="checkbox"/>	L4915AN	L4915M2AN
MERDİVEN BOŞLUĞU LAMBASI SEMBOLLÜ	<input type="checkbox"/>	N4915BN	N4915M2BN
	<input type="checkbox"/>	NT4915BN	NT4915M2BN
	<input type="checkbox"/>	L4915BN	L4915M2BN
ZİL SEMBOLLÜ	<input type="checkbox"/>	N4915DN	N4915M2DN
	<input type="checkbox"/>	NT4915DN	NT4915M2DN
	<input type="checkbox"/>	L4915DN	L4915M2DN
KİLİT SEMBOLLÜ	<input type="checkbox"/>	N4915FN	N4915M2FN
	<input type="checkbox"/>	NT4915FN	NT4915M2FN
	<input type="checkbox"/>	L4915FN	L4915M2FN
DİMMER SEMBOLLÜ	<input type="checkbox"/>		N4915M2ADN
	<input type="checkbox"/>		NT4915M2ADN
	<input type="checkbox"/>		L4915M2ADN
"DO NOT DISTURB" SEMBOLLÜ	<input type="checkbox"/>	N4915DD	N4915M2DD
	<input type="checkbox"/>	NT4915DD	NT4915M2DD
	<input type="checkbox"/>	L4915DD	L4915M2DD
"REARRANGE THE ROOM" SEMBOLLÜ	<input type="checkbox"/>	N4915MR	
	<input type="checkbox"/>	NT4915MR	
	<input type="checkbox"/>	L4915MR	



NT4915AN



NT4915BN



NT4915DN



NT4915FN



NT4915M2ADN



NT4915DD



NT4915MR



# KLASİK ANAHTARLAR İÇİN RENKLİ TUŞ KAPAKLARI

## DİK DÖRTGEN ÇERÇEVELER İÇİN IŞIKLANDIRILABİLİR TUŞ KAPAKLARI

		1 modül	2 modül	3 modül
Tanım		Ref.	Ref.	Ref.
MAT ALTIN	○	LN49310A	LN4931M20A	LN4931M30A
BRONZ	○	LN4931BZ	LN4931M2BZ	LN4931M3BZ
NİKEL	○	LN4931NS	LN4931M2NS	LN4931M3NS
GÜMÜŞ	○	LN4931AG	LN4931M2AG	LN4931M3AG



LN49310A



LN4931BZ



LN4931NS



LN4931AG

## ELİPTİK ÇERÇEVELER İÇİN IŞIKLANDIRILABİLİR TUŞ KAPAKLARI

		1 modül	2 modül	3 modül
Tanım		Ref.	Ref.	Ref.
ALTIN	○	LN49310C	LN4931M20C	LN4931M30C
ÇELİK	○	LN4931AC	LN4931M2AC	LN4931M3AC
TİTANYUM	○	LN4931TC	LN4931M2TC	LN4931M3TC
KROM	○	LN4931CR	LN4931M2CR	LN4931M3CR



LN49310C



LN4931AC



LN4931TC



LN4931CR

# AXIAL ANAHTARLAR İÇİN TUŞ KAPAKLARI

		IŞIKLANDIRILABİLİR SEMBOLSÜZ TUŞ KAPAKLARI	
		1 modül	2 modül
Tanım		Ref.	Ref.
IŞIKLANDIRILABİLİR TUŞ KAPAĞI	<input type="checkbox"/>	N4916	N4916M2
	<input type="checkbox"/>	NT4916	NT4916M2
	<input type="checkbox"/>	L4916	L4916M2



		IŞIKLANDIRILABİLİR SEMBOLLÜ TUŞ KAPAKLARI	
		1 modül	2 modül
Tanım		Ref.	Ref.
LAMBA SEMBOLLÜ	<input type="checkbox"/>	N4916A	N4916M2A
	<input type="checkbox"/>	NT4916A	NT4916M2A
	<input type="checkbox"/>	L4916A	L4916M2A
MERDİVEN BOŞLUĞU LAMBASI SEMBOLLÜ	<input type="checkbox"/>	N4916B	N4916M2B
	<input type="checkbox"/>	NT4916B	NT4916M2B
	<input type="checkbox"/>	L4916B	L4916M2B
ZİL SEMBOLLÜ	<input type="checkbox"/>	N4916D	N4916M2D
	<input type="checkbox"/>	NT4916D	NT4916M2D
	<input type="checkbox"/>	L4916D	L4916M2D
KİLİT SEMBOLLÜ	<input type="checkbox"/>	N4916F	N4916M2F
	<input type="checkbox"/>	NT4916F	NT4916M2F
	<input type="checkbox"/>	L4916F	L4916M2F



**Not:** bu tuş kapakları mekanizmayla birlikte temin edilebilen orijinal tuş kapaklarının yerine de kullanılabilir.

		IŞARET KİTLERİ KULLANILARAK KİŞİSELLEŞTİRİLEBİLİNEN TUŞ KAPAKLARI	
		1 modül	2 modül
Tanım		Ref.	Ref.
KİŞİSELLEŞTİRİLEBİLEN TUŞ KAPAKLARI	<input type="checkbox"/>	N4916T	N4916M2T
	<input type="checkbox"/>	NT4916T	NT4916M2T
	<input type="checkbox"/>	L4916T	L4916M2T



**Not:** bu tuş kapakları mekanizmayla birlikte temin edilebilen orijinal tuş kapaklarının yerine de kullanılabilir.

		IŞARET KİTLERİ	
		Ref.	
YAN TARAFTA GÖSTERİLEN IŞARETLER KULLANILARAK OLUŞTURULAN KİTLER (HER TİPTEN 5 ADET)	<input type="checkbox"/>	N4916KIT	
	<input type="checkbox"/>	NT4916KIT	
	<input type="checkbox"/>	L4916KIT	

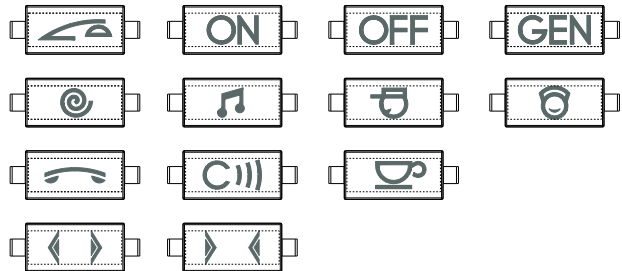

# DİĞER KONTROL MEKANİZMALARI



N4002N N4012 N4011



NT4027 NT4391 NT4016



L4037 LN4040 26108L



NT4022 NT4033



L4038R L4038V

Ref.	16 AX 250 V AC ANAHTARLAR
<input type="checkbox"/> N4002N <input type="checkbox"/> NT4002N <input type="checkbox"/> L4002N	2 kutup anahtar
<input type="checkbox"/> N4012 <input type="checkbox"/> NT4012 <input type="checkbox"/> L4012	2 kutup kilitli anahtar. Kilit anahtarı hem AÇIK hem KAPALI konumunda çıkarılabilir. Kilit anahtarları her cihaz için farklıdır.
<input type="checkbox"/> N4012C* <input type="checkbox"/> NT4012C* <input type="checkbox"/> L4012C*	2 kutup kilitli anahtar – yukarıdaki gibi – Kilit anahtarları her cihaz için aynıdır.

\*NOT: Sipariş vermek için lütfen tedarikçinizle irtibata geçiniz.

Ref.	32 A İKİ KUTUP ANAHTAR
<input type="checkbox"/> N4011 <input type="checkbox"/> NT4011 <input type="checkbox"/> L4011	32 A – 250 V AC 2 kutup anahtar

Ref.	16 AX 250 V AC VAVİEN
<input type="checkbox"/> N4022 <input type="checkbox"/> NT4022 <input type="checkbox"/> L4022	1 kutup kilitli VAVİEN. Kilit anahtarı hem AÇIK hem KAPALI konumunda çıkarılabilir. Kilit anahtarları her cihaz için farklıdır.
<input type="checkbox"/> N4022C* <input type="checkbox"/> NT4022C* <input type="checkbox"/> L4022C*	1 kutup kilitli VAVİEN – yukarıdaki gibi – Kilit anahtarları her cihaz için aynıdır.

\*NOT: Sipariş vermek için lütfen tedarikçinizle irtibata geçiniz.

Ref.	16 A 250 V AC JALUZI ANAHTAR
<input type="checkbox"/> N4037 <input type="checkbox"/> NT4037 <input type="checkbox"/> L4037	1 kutup, 1-0-2 iki tuşlu enversör anahtar
<input type="checkbox"/> N4037 <input type="checkbox"/> NT4037 <input type="checkbox"/> L4037	1 kutup (NA) + 1 kutup (NA) otomatik çift tuşlu lith butonu

Ref.	FAN ANAHTARI
<input type="checkbox"/> N4027 <input type="checkbox"/> NT4027 <input type="checkbox"/> L4027	Yukarıdaki gibi fan sembolü

Ref.	JAK BAĞLANTISI
<input type="checkbox"/> N4391 <input type="checkbox"/> NT4391 <input type="checkbox"/> L4391	2 kontaklı 48 V 10 A jak bağlantısı (2124N kodlu ürün için)
<input type="checkbox"/> 2124N	L/N/NT4391 için fiş/jak

Ref.	HIZ KONTROL ANAHTARI
<input type="checkbox"/> N4016 <input type="checkbox"/> NT4016 <input type="checkbox"/> L4016	4 kademeli fan kontrol anahtarı 3 A 250 V AC

Ref.	10 A 250 V AC LİHT BUTONLARI
<input type="checkbox"/> N4034N <input type="checkbox"/> NT4034N <input type="checkbox"/> L4034N	Tek kutuplu (NK) değiştirilebilir tuş kapaklı LİHT butonu
<input type="checkbox"/> N4036 <input type="checkbox"/> NT4036 <input type="checkbox"/> L4036	1 kutup (NA) + 1 kutup (NA) Çift tuşlu LİHT butonu
<input type="checkbox"/> N4033 <input type="checkbox"/> NT4033 <input type="checkbox"/> L4033	1 kutup (NA) kordonlu LİHT butonu
<input type="checkbox"/> N4038R <input type="checkbox"/> NT4038R <input type="checkbox"/> L4038R	1 kutup (NA) LİHT butonu + LN4742V12T – LN4742V230T LED'ler için, kırmızı renk göstergeli
<input type="checkbox"/> N4038V <input type="checkbox"/> NT4038V <input type="checkbox"/> L4038V	yukarıdaki gibi – yeşil renk göstergeli
<input type="checkbox"/> N4044N <input type="checkbox"/> NT4044N <input type="checkbox"/> L4044N	2 kutup NA geleneksel hastane sistemleri için bağımsız kontaklı LİHT butonu
<input type="checkbox"/> LN4040	1 kutup (NA) LİHT butonu + LN4742V12 TLN4742V230T LED'ler için ışıklı etiket plakalı
<input type="checkbox"/> N4042N <input type="checkbox"/> NT4042N <input type="checkbox"/> L4042N	1 kutup (NA) ışıklı ve zil sembolü LİHT butonu
<input type="checkbox"/> N4042M2N <input type="checkbox"/> NT4042M2N <input type="checkbox"/> L4042M2N	1 kutup (NA) ışıklı ve zil sembolü LİHT butonu – 2 modül
<input type="checkbox"/> N4043N <input type="checkbox"/> NT4043N <input type="checkbox"/> L4043N	1 kutup (NA) ışıklı ve lamba sembolü LİHT butonu
<input type="checkbox"/> N4043M2N <input type="checkbox"/> NT4043M2N <input type="checkbox"/> L4043M2N	1 kutup (NA) ışıklı ve lamba sembolü LİHT butonu – 2 modül
<input type="checkbox"/> 26108N <input type="checkbox"/> 26108T <input type="checkbox"/> 26108L	-IP55 etiketli lith butonu- aydınlatmalı LED teknolojisi-503E ve 502E örme duvar yapıları ile uyumlu

Ref.	TUŞ KAPAKLARI
<input type="checkbox"/> N4916DP <input type="checkbox"/> NT4916DP <input type="checkbox"/> L4916DP	nötr tuş kapakları. ref: N / NT / L4036, N / NT / L4038R, N / NT / L4038V - 10 adetlik paket
<input type="checkbox"/> N4916DPA <input type="checkbox"/> NT4916DPA <input type="checkbox"/> L4916DPA	ok sembolü tuş kapakları. ref: N/NT/L4027, N/NT/L4037 10 adetlik paket.

# DİMMERLER



N4402N



NT4406



NT4408N  
NT4410N  
NT4411N



L4581

Ref.		<b>ROTATİF DİMMER</b>
□ N4402N*		rotatif VAVİEN anahtarlı dimmer
■ NT4402N*		- rezistif 60-500W
■ L4402N*		- TRIAC/IGBT teknoloji, dahili sigorta - 1 modül
□ N4406*		rezistif rotatif dimmer
■ NT4406*		-100-500W, 1 modül
■ L4406*		
□ N4581		rezistif rotatif dimmer
■ NT4581		-100-500W, 1 modül
■ L4581		

\*NOT: dimmerlerin AIR ÇERÇEVELERLE kullanımında, estetik bir görünüm ve düzlemsel bir aydınlatma için yeni dimmer liht butonlarının kullanımı önerilir. Alternatif olarak, eğer, L/N/NT4002N ve L/N/NT4406 kurulumu yapıyorsa, kurulumda kolaylık açısından buat genişletme aksesuarı kullanımı tavsiye edilir.

Ref.		<b>DOKUNMATİK DİMMERLER</b>
□ N4408N		rezistif/endüktif elektronik korumalı
■ NT4408N		dokunmatik dimmer 300/600W – 2 modül
■ L4408N		
□ N4410N		elektronik korumalı, 0-10V çıkışlı, dokunmatik
■ NT4410N		dimmer
■ L4410N		
□ N4582N		rezistif/kapasitif dokunmatik dimmer
■ NT4582N		400/700 W
■ L4582N		- 2 modül

Ref.		<b>ÜNİVERSAL DİMMER</b>
□ N4411N		üniversal dimmer (rezistif/endüktif, kapasitif,
■ NT4411N		kompakt floresan ve dimlenebilir LED)
■ L4411N		150/200/400W elektronik korumalı- 2 modül

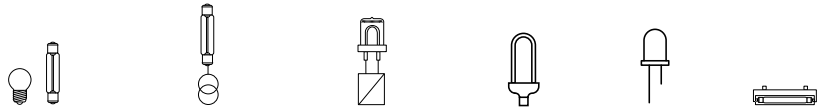

Yükler									
Ref.	yük tipi	gerilim/ frekans	gerilim standardı	akkor filamanlı/ halojen	Ferromanyetik trafolu halojen	Elektronik trafolu ELV halojen	Dimlenebilir kompakt floresan	Dimlenebilir LED lamba	0-10 V balastlı floresan lamba
N4402N NT4402N L4402N	Rezistif	230 V AC. 50 Hz	230 V AC.	60 - 500 W					
N4406 NT4406 L4406	Rezistif	230 V AC. 50 - 60 Hz	230 V AC.	100 - 500 W					
N4408N NT4408N L4408N	Rezistif Endüktif	100 - 240 V AC. 50 - 60 Hz	240 V AC. 100 V AC.	20 - 600 W 20 - 300 W	20 - 600 VA 20 - 300 VA				
N4410N NT4410N L4410N	0 - 10 V	100 - 240 V AC. 50 - 60 Hz	240 V AC. 100 V AC.						20 - 600 VA 20 - 300 VA
N4411N NT4411N L4411N	Üniversal	100÷240 V AC. 50÷60 Hz	240 V AC. 100 V AC.	3 ÷ 400 W 3 ÷ 200 W	3 ÷ 400 VA 3 ÷ 200 VA	3 ÷ 400 VA 3 ÷ 200 VA	3 - 150 VA 3 - 75 VA	3 - 150 VA 3 - 75 VA	
N4581 NT4581 L4581	Rezistif	110 - 230 V AC. 50 - 60 Hz	230 V AC. 127 V AC.	50 - 800 W 50 - 400 W					
N4582N NT4582N L4582N	Rezistif Kapasitif	110 - 230 V AC. 50 - 60 Hz	127 V AC. 230 V AC.	50 - 400 W 50 - 700 W	50 - 400 W 50 - 700 W		50 - 300 W 50 - 300 W		100 - 300 W 100 - 500 W

# HAREKET DEDEKTÖRLERİ VE ELEKTRONİK KONTROL MEKANİZMALARI

**N4433N**

**N4434N**

**NT4431**

**L4432**

Ref.



## HAREKET DEDEKTÖRLERİ

- N4433N
- NT4433N
- L4433N



Dual Sensör (PIR+Ultrasonik): Ultrasonik ses dalgaları ve kızılötesi ile birlikte çalışır. Ön düğmeyi kullanarak ışık açılır ve parlaklık seviyesi otomatik olarak hareket sensörleri sayesinde ayarlanır. Parlaklık seviyesi uzaktan kumanda edilebilir ya da manuel olarak da ayarlanabilir.

– 2 modül

- N4434N
- NT4434N
- L4434N



Dual Sensör (PIR+Ultrasonik): Ultrasonik ses dalgaları ve kızılötesi ile birlikte çalışır. Ön düğmeyi kullanarak ışık açılır ve parlaklık seviyesi otomatik olarak hareket sensörleri sayesinde ayarlanır. Parlaklık seviyesi uzaktan kumanda edilebilir ya da manuel olarak da ayarlanabilir.

– 2 modül

## HAREKET DEDEKTÖRLERİ

- N4431
- NT4431
- L4431



pasif IR hareket dedektörü anahtarı, ayarlanabilen karanlık algılama devresi – istenirse haric tutulabilir – gecikmeli kapatma devresi – 3 sn ile 10 dk arasında ayarlanabilir – röle çıkışlı 2A rezistif / 2A endüktif – 230 V AC güç kaynağı – 1 modül

- N4432
- NT4432
- L4432



yukarıdaki gibi – istenirse harici düğmeler ile kumanda edilebilir. Röle çıkışlı 6A rezistif / 2A endüktif 0-A-1 selektörlü, 230 V AC güç kaynağı – 2 modül

## HAREKET DEDEKTÖRÜ - ÖZELLİKLERİ

	N4433N NT4433N L4433N	N4434N NT4434N L4434N
	100-240 V~	
	50/60 Hz	
	2 x 2.5 mm <sup>2</sup>	
NÖTR BAĞLANTISI	EYET	HAYIR
	(-5) - (+45) °C	
	300 lux	
	15 dakika	
	2000 W - 230 V~ 1000 W - 110 V~	40÷400 W - 230 V~ 20÷200 W - 110 V~
	1000 VA - 230 V~ - 4,3 A 500 VA - 110 V	40÷400 VA - 230 V~ 20÷200 VA - 110 V~
	10 x (2x36 W) - 230 V~ 5 x (2x36 W) - 110 V~	
	500 VA - 230 V~ 250 VA - 110 V~	
	1000 VA - 230 V~ 500 VA - 110 V~	
	500 VA - 230 V~ 250 VA - 110 V~	

## SICAKLIK KONTROLÜ





N4441

N4451



NT4442



L4450

Ref.	ELEKTRONİK ORTAM TERMOSTATI
<input type="checkbox"/> N4441 <input type="checkbox"/> NT4441 <input checked="" type="checkbox"/> L4441	 elektronik ortam termostati – tek çıkışlı röle 2A 250 V AC ve 230 V AC güç kaynağı
<input type="checkbox"/> N4441FH <input type="checkbox"/> L4441FH <input checked="" type="checkbox"/> NT4441FH	 elektronik ortam termostati – tek çıkışlı röle 2A 250 V AC ve 230 V AC güç kaynağı - harici sensör bağlantısı
<input type="checkbox"/> N4442 <input type="checkbox"/> NT4442 <input checked="" type="checkbox"/> L4442	 "yaz/kış" seçimli elektronik ortam termostati 0-NA 2A 50 V AC enversör kontaklı 230 V AC güç kaynağı

Ref.	KRONOTERMOSTAT
<input type="checkbox"/> N4451 <input type="checkbox"/> NT4451 <input checked="" type="checkbox"/> L4451	 ısıtma ve iklimlendirme sistemleri için günlük/haftalık programlanabilir sıva altı kronotermostat. 24 saatlik zaman diliminde seçilebilir 3 sıcaklık ayarı – otomatik, manuel, tatil, donmaya karşı koruma- aydınlatmalı ekran. 2 adet 1,5V güç kaynağı ile çalışır. Uzaktan kumanda ile kontrol – harici sensör kullanılarak uzaktan aktivasyon olanağı.
<input type="checkbox"/> N4450 <input type="checkbox"/> NT4450 <input checked="" type="checkbox"/> L4450	 ısıtma ve iklimlendirme sistemleri için günlük/haftalık programlanabilir sıva üstü kronotermostat. 24 saatlik zaman diliminde seçilebilir 3 sıcaklık ayarı – otomatik, manuel, tatil, donmaya karşı koruma- aydınlatmalı ekran. 2 adet 1,5V güç kaynağı ile çalışır. Uzaktan kumanda ile kontrol – harici sensör kullanılarak uzaktan aktivasyon olanağı.

Ref.	KRONOTERMOSTATLAR İÇİN AKSESUARLAR
<input type="checkbox"/> F462	 GSM telefon aktüatörü – 4 DIN modül
<input type="checkbox"/> 3457	 L/N/NT4450 ve L/N/NT4451 için harici sensör

## GAZ DEDEKTÖRLERİ



NT4511/2



NT4520

L4541

L4525/12NO





F91/12E

Ref.	GAZ DEDEKTÖRLERİ
<input type="checkbox"/> N4511/12 <input type="checkbox"/> NT4511/12 <input checked="" type="checkbox"/> L4511/12	 kendi kendini ayarlayabilen, görsel ve sesli alarmlı metan gazı dedektörü – sinyal tekrarlama kontrolü - 12 V AC / d.c güç kaynağı – 2 modül
<input type="checkbox"/> N4512/12 <input type="checkbox"/> NT4512/12 <input checked="" type="checkbox"/> L4512/12	 yukarıdaki gibi - LPG için

Ref.	SİNYAL TEKRARLAYICI
<input type="checkbox"/> N4520 <input type="checkbox"/> NT4520 <input checked="" type="checkbox"/> L4520	 görsel ve sesli gaz dedektörü sinyal tekrarlayıcısı, 1 röle çıkışlı, 6A rezistif, 2A endüktif, manuel sıfırlama için elektromanyetik valf kontrolü, 6A rezistif/2A endüktif, 2 modül

Ref.	TRANSFORMATÖR
<input type="checkbox"/> N4541* <input type="checkbox"/> NT4541* <input checked="" type="checkbox"/> L4541*	 gaz dedektörleri için transformatör – 230 V AC @ 50/50Hz, 4VA – 2 modül

Ref.	DİN TRANSFORMATÖRÜ
<input type="checkbox"/> F91/12E*	 gaz dedektörleri için DIN rayına monte edilebilen transformatör. 230 V AC, 12 V AC – 6VA – 3 modül

Ref.	SELENOID VALF
<input type="checkbox"/> L4525/12NO	 NO gaz selenoid valf – manuel ayarlı – güç kaynağı 12V 50 Hz. – güç 3VA- çalışmadığı zamanki tüketimi: 0 – maks. basınç 500mbar – IP65 koruma derecesi – çalışma ısısı -15 +60°C. -3 / 4 dişli tapalar ve ½ inç endüksiyon ile birlikte

\* Gaz dedektörlerinin doğru çalışması yalnızca bu sayfada gösterilen transformatörler kullanıldığında garanti edilir.



# PRİZLER – ALMAN, FRANSIZ VE DİĞER STANDARTLAR

**N4141PW**

**NT4142**

**L4141R**

**L4141V**

**L4139**

**L4142**

Ref.		<b>ALMAN STANDARTI</b>
<input type="checkbox"/> N4141		2P+T 16 A 250V
<input type="checkbox"/> NT4141		Çocuk korumalı, schuko topraklı priz
<input type="checkbox"/> L4141		
<input type="checkbox"/> N4141PW		Kapaklı topraklı priz
<input type="checkbox"/> NT4141PW		Çocuk korumalı, schuko topraklı priz
<input type="checkbox"/> L4141PW		Vidalı bağlantı

		<b>ALMAN STANDARTI (OTOMATİK)</b>
<input type="checkbox"/> N4141AN		2 P + E 16 A topraklı priz – otomatik – 2 modül
<input type="checkbox"/> NT4141AN		
<input type="checkbox"/> L4141AN		

		<b>ÖZEL PRİZLER</b>
<input type="checkbox"/> L4141R		2P+T 16A 250V - çocuk korumalı - topraklı - Alman standardı priz, kırmızı
<input type="checkbox"/> L4141A		2P+T 16A 250V - çocuk korumalı, - topraklı, - Alman standardı priz - turuncu
<input type="checkbox"/> L4141V		2P+T 16A 250V - çocuk korumalı, - topraklı, - Alman standardı priz - yeşil

		<b>İTALYAN STANDARTI</b>
<input type="checkbox"/> N4113		2 Kutup+T 10 A 250 V a.c. priz merkez uzaklık 19 mm
<input type="checkbox"/> NT4113		
<input type="checkbox"/> L4113		

Ref.		<b>FRANSIZ STANDARTI (UPS)</b>
<input type="checkbox"/> N4142		2P+T 16A 250 V AC Çocuk korumalı, topraklı priz
<input type="checkbox"/> NT4142		
<input type="checkbox"/> L4142		
<input type="checkbox"/> L4142AR		2P+T 16A 250 V AC Çocuk korumalı, topraklı priz - vidalı - kırmızı
<input type="checkbox"/> N4142AN		2P+T 16A 250 V AC Çocuk korumalı, topraklı priz, otomatik
<input type="checkbox"/> NT4142AN		
<input type="checkbox"/> L4142AN		

		<b>İNGİLİZ STANDARTI</b>
<input type="checkbox"/> N4150		2 modül - 13 AMP
<input type="checkbox"/> NT4150		(BS 1363)
<input type="checkbox"/> L4150		
<input type="checkbox"/> N4151 / NT4151		1 gang anahtarlı priz 13A
<input type="checkbox"/> N4152 / NT4152		2 gang anahtarlı priz 13A
<input type="checkbox"/> N4153 / NT4153		3 gang anahtarlı priz 15A

		<b>TIRAŞ</b>
<input type="checkbox"/> N4177*		izoleli trafolu tıraş prizi
<input type="checkbox"/> NT4177 *		- giriş 230V a.c. 50/60Hz
<input type="checkbox"/> L4177*		- çıkış 115/230V a.c. 20VA - 3 modül

**\*Not:** LIVINGLIGHT AIR çerçevelerle birlikte kullanılırken kolay kablolama için  
buat genişletme aksesuarı kullanılması önerilir.

		<b>MULTISTANDARD</b>
<input type="checkbox"/> N4139		2 P+T 5/6/10/13 A 230 V AC. ve 127 V AC. priz
<input type="checkbox"/> NT4139		- 2 modül
<input type="checkbox"/> L4139		

**Not:** diğer uluslararası standartlara uygun prizler için satış ofislerimize danışınız.

## EKRANLANMIŞ TV PRİZLERİ



LN4202D NT4210D LN4214D



LN4202F NT4202M2D S2133

Ref.		<b>YILDIZ BAĞLANTILI TV PRİZİ</b>
○ LN4202D*		Yıldız TV prizi, 1 modül
○ LN4202M2D*		Yıldız TV prizi, 2 modül
<b>GEÇİŞLİ TV PRİZİ</b>		
○ LN4202P14*		Geçişli TV prizi, 14 dB
<b>TV BAĞLANTI TERMİNALİ</b>		
○ LN4202P10*		Sonlu TV prizi, 10 dB
<b>F TİPİ TV SAT PRİZİ</b>		
○ LN4202F*		F tipi yıldız uydu prizi
<b>TV SAT PRİZİ</b>		
○ LN4214D*		TV SAT prizi, 1 modül
○ LN4214M2D*		TV SAT prizi, 2 modül
<b>TV/R/SAT PRİZLER</b>		
○ LN4210M2D*		TV/R/SAT prizi, 2 modül
<b>*Not:</b> ürün ambalajında 3 renk tuş kapağı mevcuttur.		
<b>TV PRİZ VE SOKETİ</b>		
○ S2133		Beyaz TV soketi
<b>SONLANDIRMA DİRENCİ</b>		
○ 75RTN		Hat sonunda görüntü eşitlemek için 75 Ohm sonlandırma sağlar.

## DATA PRİZLERİ



N4261AT5 NT4262C5E L4279C5E  
N4261AT6 N4262C6 L4279C6



L4262C6S

Ref.		<b>RJ45 PRİZLER</b>
		RJ45 data iletimi/telefon bağlantısı. Özel olarak data iletimi ve telefon bağlantısı için tasarlanmıştır. Yaygın olarak 4 çift kablo ile bilgisayar ağları için kullanılmaktadır.
		<b>Kategori</b> <b>Bağlantı tipi</b>
□ N4279C5E ■ NT4279C5E ■ L4279C5E		5E UTP ALETSİZ IDC
□ N4279C5F ■ NT4279C5F ■ L4279C5F		5 FTP ALETSİZ IDC
□ N4279C6 ■ NT4279C6 ■ L4279C6		6 UTP ALETSİZ IDC
□ N4279C6F ■ NT4279C6F ■ L4279C6F		6 FTP ALETSİZ IDC
□ N4279C6S ■ NT4279C6S ■ L4279C6S		6 STP ALETSİZ IDC
□ N4279C6A ■ NT4279C6A ■ L4279C6A		6A STP ALETSİZ IDC
□ N4262C5E ■ NT4262C5E ■ L4262C5E		5E UTP 110 IDC
□ N4262C6 ■ NT4262C6 ■ L4262C6		6 UTP 110 IDC
□ N4262C6S ■ NT4262C6S ■ L4262C6S		6 STP 110 IDC
□ N4261AT5 ■ NT4261AT5 ■ L4261AT5		5E UTP 110 IDC
□ N4261AT6 ■ NT4261AT6 ■ L4261AT6		6 UTP 110 IDC

# TELEFON VE DATA VE ÖZEL PRİZLER

**LN4285CW2**

**L4285C2**

**L4285C1**

**L4269R**

**L4284**

**N4258/11D**

**N4294**

Ref.	<b>RJ11 – RJ12 PRİZLER</b>	
	Bu konnektörler telefon bağlantılarının gereksinimlerini karşılamak üzere dizayn edilmiştir.	
	Jack tipi	Bağlantı tipi
<input type="checkbox"/> N4258/11D <input type="checkbox"/> NT4258/11D <input type="checkbox"/> L4258/11D		RJ11 K10 2 modül
<input type="checkbox"/> N4258/11N <input type="checkbox"/> NT4258/11N <input type="checkbox"/> L4258/11N		RJ11 K10
<input type="checkbox"/> N4258/12D <input type="checkbox"/> NT4258/12D <input type="checkbox"/> L4258/12D		RJ12 K10 2 modül

(1) Bağlantı tipi 110

<b>USB ŞARJ PRİZİ</b>	
<input type="checkbox"/> N4285C1 <input type="checkbox"/> NT4285C1 <input type="checkbox"/> L4285C1	<p>USB prize 5 V DC akıllı telefon, tablet ve benzeri elektronik aletleri şarj etmek için kullanılır. 1 A- 230 V AC.</p>
<input type="checkbox"/> N4285C2 <input type="checkbox"/> NT4285C2 <input type="checkbox"/> L4285C2	<p>USB prize 5 V DC 1 veya 2 cihaz şarjı için kullanılır 1 cihaz 2A - 2 cihaz 1A - 230 V AC. içinden 3 farklı renkte tuş kapağı çıkar</p>

<b>İNDÜKTİF ŞARJ CİHAZI</b>	
<input type="checkbox"/> LN4285CW2	<p>İndüktif yapı ile hızlı ve kablosuz şarj sağlar Yatak başı, sehpalar, masalar ve WPCQI (Dünya Güç Konsorsiyumu) ve EN standardı 62479 (CEM emisyonları) standardına uygundur. Kablosuz yayılım değeri düşük olduğundan diğer haberleşme bantlarını etkilemez. Enerji verimliliği &gt; % 85. 2.400 mA Boyut 136,5 x 70 x 56,5 mm</p>

<b>ÖZEL PRİZLER</b>	
<input type="checkbox"/> N4291 <input type="checkbox"/> NT4291 <input type="checkbox"/> L4291	<p>2 kutuplu mini soket – giriş çapı 3mm-13mm aralıklı- harici ve benzer devreler için – 6A 24V SELV</p>
<input type="checkbox"/> N4292 <input type="checkbox"/> NT4293 <input type="checkbox"/> L4292	<p>5 kutup DIN Hi-Fi veya benzeri bağlantı için.</p>
<input type="checkbox"/> N4293 <input type="checkbox"/> NT4293 <input type="checkbox"/> L4293	<p>2 kutuplu DIN konnektör – kaynak yapılabilir</p>

Ref.	<b>AUDIO VIDEO PRİZLER</b>	
<input type="checkbox"/> N4269R <input type="checkbox"/> NT4269R <input type="checkbox"/> L4269R	<p>çift RCA konnektör – kırmızı, sarı - kaynak yapılabilecek şekilde sonlandırılmıştır</p>	
<input type="checkbox"/> N4294 <input type="checkbox"/> NT4294 <input type="checkbox"/> L4294	<p>Ev sinema sistemi için hoparlör konnektörü</p>	
<input type="checkbox"/> N4280 <input type="checkbox"/> NT4280 <input type="checkbox"/> L4280	<p>konnektör – jack 3.5</p>	
<input type="checkbox"/> N4281 <input type="checkbox"/> NT4281 <input type="checkbox"/> L4281	<p>konnektör – RCA x 2</p>	
<input type="checkbox"/> N4282 <input type="checkbox"/> NT4282 <input type="checkbox"/> L4282	<p>konnektör – HD15</p>	
<input type="checkbox"/> N4283 <input type="checkbox"/> NT4283 <input type="checkbox"/> L4283	<p>RCA x 3 konnektör</p>	
<input type="checkbox"/> N4284 <input type="checkbox"/> NT4284 <input type="checkbox"/> L4284	<p>HDMI konnektör</p>	
<input type="checkbox"/> N4285 <input type="checkbox"/> NT4285 <input type="checkbox"/> L4285	<p><b>DATA PRİZİ</b> USB prize</p>	

# SESLİ VE IŞIKLI SİNYALİZASYON MEKANİZMALARI



N4351/12



NT4355/12



L4357/12



L4371V





N4371R







L4385/..











L4374V12V24

Ref.	ZİLLER
□ N4351/12 ■ NT4351/12 ■ L4351/12	 mekanik zil 12 V AC – 5VA - 80db
□ N4351/230 ■ NT4351/230 ■ L4351/230	 mekanik zil 230 V AC – 8VA - 80db -50 ve 60Hz
□ N4355/12 ■ NT4355/12 ■ L4355/12	 3 melodi seçeneqli, ses ayarlı, elektronik zil – 12 V AC –d.c – 2 modül

Ref.	BAZERLER
□ N4356/12 ■ NT4356/12 ■ L4356/12	 bazer 12 V AC – 5VA – 74db
□ N4356/230 ■ NT4356/230 ■ L4356/230	 bazer 230 V AC – 8VA – 75db- 50 ve 60 Hz



Ref.	KILAVUZ LAMBALAR
□ N4371A ■ NT4371A ■ L4371A	 turuncu gösterge lambası LN4742V12T, LN4742V127T ve LN4742V230T LED için
□ N4371T ■ NT4371T ■ L4371T	 transparan gösterge lambası LN4742V12T, LN4742V127T ve LN4742V230T LED için
□ N4371R ■ NT4371R ■ L4371R	 kırmızı gösterge lambası LN4742V12T, LN4742V127T ve LN4742V230T LED için
□ N4371V ■ NT4371V ■ L4371V	 yeşil gösterge lambası LN4742V12T, LN4742V127T ve LN4742V230T LED için
□ N4372AV ■ NT4372AV ■ L4372AV	 turuncu ve yeşil gösterge lambası LN4742V12T, LN4742V127T ve LN4742V230T LED için
□ N4372RT ■ NT4372RT ■ L4372RT	 turuncu ve yeşil gösterge lambası LN4742V12T, LN4742V127T ve LN4742V230T LED için

Ref.	IŞIKLI SİNYALİZASYON MEKANİZMALARI
■ L4385/12R ■ L4385/12V ■ L4385/12B	 12 V – kırmızı, yeşil, beyaz
■ L4385/24R ■ L4385/24V ■ L4385/24B	 24 V kırmızı, yeşil , beyaz
■ L4385/230R ■ L4385/230V ■ L4385/230B	 230 V – kırmızı, yeşil, beyaz
○ L4745/12	 tasarruflu lamba E10 12 V – 5 W
○ L4745/24	 tasarruflu lamba E10 24 V – 5 W
○ L4745/230	 tasarruflu lamba E10 230 V – 5 W

Ref.	SİNYAL LAMBASI
○ L4374V12V24	 beyaz LED'li sinyal lambası – 12/24 V AC.
○ L4374/230	 beyaz LED'li sinyal lambası – 230 V AC



# EMNİYET VE İKAZ LAMBALARI



MERDİVEN BASAMAĞI LAMBASI	
<input type="radio"/> L4382V12V24	 Beyaz LED'li merdiven basamağı lambası – 12/24 V AC
<input type="radio"/> L4382/230	 Beyaz LED'li merdiven basamağı lambası – 230 V AC



360° ODAKLI LAMBA	
<input type="radio"/> LN4360	 mutfak, yatak odası, masa gibi kullanılacağı alanın üzerine monte edilir. Alanın ihtiyacı olan en iyi aydınlatma için çözüm sunan 360° odaklı lamba. - anahtar, nötrsüz elektronik anahtarlar, dimmer ve nötrlü hareket dedektörleri ile kontrol edilebilir. - nötr tabanı ve 3 farklı renkteki ön kapakları ile birlikte temin edilir. - 2 modül

YÖNLÜ ZEMİN LAMBASI	
<input type="radio"/> LN4361	 yönlü ve dekoratif aydınlatma yaratmanıza olanak verir. Zeminden 30 cm yukarıya monte edilmesi önerilir. - anahtar, nötrsüz elektronik anahtarlar, dimmer ve nötrlü hareket dedektörleri ile kontrol edilebilir. - nötr tabanı ve 3 farklı renkteki ön kapakları ile birlikte temin edilir. - 2 modül

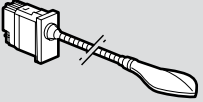

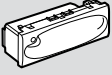
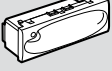

DİMLENEBİLEN MOBİL LAMBA	
<input type="radio"/> LN4380N	 mobil, el feneri, 3 farklı tuş kapağı ile birlikte tedarik edilir.
4380NB	 LN43780N için batarya

DİMLENEBİLEN OKUMA LAMBASI	
<input type="checkbox"/> N4362 <input type="checkbox"/> NT4362 <input checked="" type="checkbox"/> L4362	 siva altı okuma lambası, dimlenebilir, LED, 1 modül



ACİL DURUM LAMBALARI	
Ref. <input type="radio"/> L4384/1	 enerji kesilmesi durumunda otomatik olarak devreye giren ışıklı acil durum lambası – LIHT butonu ile manuel olarak devre dışı bırakılabilir – Ni-Cd bataryalarla şarj edilir. - 1 saat çalışma rezervi 230 V AC besleme, 50 ve 60 Hz – 1W lamba – 4 modül
<input type="radio"/> L4384/3*	 Yukardaki gibi – 3 saat çalışma rezervi – 4 modül
<input type="radio"/> L4386/1	 Yukardaki gibi – 1 saat çalışma rezervi – 1.3W lamba – 6 modül
<input type="radio"/> L4386/3*	 Yukardaki gibi – 3 saat çalışma rezervi – 6 modül

\*NOT: eğer AIR çerçeveler ile kullanılacaksa, montaj kolaylığı için buat genişletme aksesuarı kullanınız.

YEDEK BATARYALAR	
<input type="radio"/> L4784/1	 Ref. L4384/1 için
<input type="radio"/> L4784/3	 Ref. L4384/3 için
<input type="radio"/> L4786/1	 Ref. L4386/1 ve L4386/1L için
<input type="radio"/> L4786/3	 Ref. L4386/3 ve L4386/3L için

# BOŞLUK KAPAKLARI



N4950



L4951

Ref.		BOŞLUK KAPAKLARI
<input type="checkbox"/> N4950 <input type="checkbox"/> NT4950 <input checked="" type="checkbox"/> L4950		1 modül boşluk kapağı
<input type="checkbox"/> N4951 <input type="checkbox"/> NT4951 <input checked="" type="checkbox"/> L4951		Açma çıkıntısı olan 2 modül boşluk kapağı
<input type="checkbox"/> N4952 <input checked="" type="checkbox"/> L4952		1 modül boşluk kapağı, klemens
<input type="checkbox"/> N4953 <input type="checkbox"/> NT4953 <input checked="" type="checkbox"/> L4953		9 mm çaplı 1 modül çıkışlı boşluk kapağı
<input type="checkbox"/> N4954 <input type="checkbox"/> NT4954 <input checked="" type="checkbox"/> L4954		9 mm çaplı 2 modül çıkışlı boşluk kapağı



# LED'LER VE PİLOT LAMBALAR



LN4742V12T



LN4742V230



LN4743/230A

Ref.	STANDART ANAHTARLAR İÇİN LED'ler
○ LN4742V230	LED - kehribar
○ LN4742V12	LED 12 /24 V - kehribar
○ LN4742V230V	LED 230 V - yeşil
○ LN4742V12V	LED 12 /24 V - yeşil
○ LN4742V230T	pilot lambalar - beyaz - LED
○ LN4742V12T	pilot lambalar - beyaz - LED

Ref.	AXIAL ANAHTARLAR İÇİN LED'ler
○ LN4743/230A	LED 230 V - kehribar
○ LN4743/12A	LED 12 /24 V - kehribar
○ LN4743/230V	LED 230 V - yeşil
○ LN4743/12V	LED 12 /24 V - yeşil
○ LN4743/230T	LED 230 V - beyaz
○ LN4743/12T	LED 12 /24 V - beyaz
○ H4743/230B	LED 230 V - mavi
○ H4743/12B	LED 12 /24 V - mavi

## LED SEÇİM TABLOSU

Işıklıdırılabilir anahtar	LED
Standart anahtar mekanizmaları	
Vidalı bağlantı	
1 modül	2 modül
LN4004	
N/NT/L4004N	N/NT/L4004M2N
N/NT/L4044N	N/NT/L4044M2N
Otomatik bağlantı	
1 modül	2 modül
LN4001A	
LN4003A	
LN4005A	
N/NT/L4001A	N/NT/L4001M2A
N/NT/L4003A	N/NT/L4003M2A
N/NT/L4005A	N/NT/L4005M2A
Axial anahtar mekanizmaları	
1 modül	2 modül
N/NT/L4051AN	N/NT/L4051M2AN
N/NT/L4053AN	N/NT/L4053M2AN
N/NT/L4054AN	N/NT/L4054M2AN
N/NT/L4055AN	N/NT/L4055M2AN
Işıklı LIHT butonları	
1 modül	
N/NT/L4038R	
N/NT/L4038V	
LN4040	
Klavuz lambalar	
1 modül	
N/NT/L4371T	
N/NT/L4371R	
N/NT/L4371V	
N/NT/L4372AV (2 LED)	
N/NT/L4373H (2 LED)	

LN4742V12 (12/24 V)  
LN4742V230 (230 V)  
LN4742V12V (12/24 V)  
LN4742V230V (230 V)

LN4743/12A (12/24 V)  
LN4743/230A (230 V)  
LN4743/12V (12/24 V)  
LN4743/230V (230 V)

LN4742V12T (12/24 V)  
LN4742V230T (230 V)  
LN4742V12T (12/24 V)  
LN4742V230T (230 V)  
LN4742V12T (12/24 V)

### ANAHTAR LED BAĞLANTISI

LED anahtara enerji tasarruflu lamba ya da floresan lamba bağlandığı durumlarda seri bağlanamaz. LED faz ve nötr arasına doğrudan bağlanmalıdır.

### ÖRNEK LED BAĞLANTI ŞEMALARI

fonksiyon: lokasyon belirtici

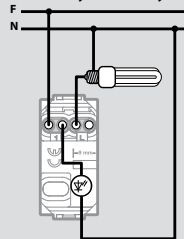

fonksiyon: yük durumu

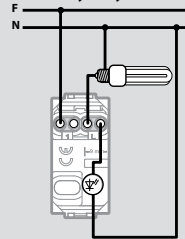

# KAİDELER

## GEÇMELİ KURULUM

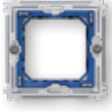

LN4702MG

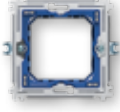

LN4702M



LN4702E



LN4702G

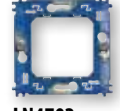

LN4702

## MODÜLER KURULUM

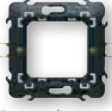

L4702G



L4702

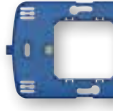

LN4719G\*

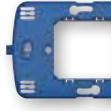

LN4719\*

\* (Sadece LNA4819 çerçeve ile kurulum yapılır)



LN4703



LN4704



LN4702C



LN4703C



LN4704C



LN4707



LN4726

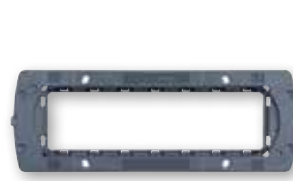

LN4707C



LN4726C

Ref.	2 MODÜL METAL KAİDELER
○ LN4702MG	Diktörgen çerçeveler için 2 modül kaide – tırnaklı
○ LN4702M	Diktörgen çerçeveler için 2 modül kaide – vidalı
Ref.	2 MODÜL PLASTİK KAİDELER
○ LN4702G	Diktörgen çerçeveler için 2 modül kaide – tırnaklı
○ LN4702	Diktörgen çerçeveler için 2 modül kaide – vidalı
Ref.	MODÜLER UYGULAMA İÇİN PLASTİK KAİDELER
○ L4702G	LIVING INTERNATIONAL çerçeveler için 2 modül kaide – tırnaklı
○ L4702	LIVING INTERNATIONAL çerçeveler için 2 modül kaide – vidalı
○ LN4719G	Diktörgen çerçeveler için 2 modül özel kaide – tırnaklı
○ LN4719	Diktörgen çerçeveler için 2 modül özel kaide- vidalı
○ LN4703	Diktörgen LIVINGLIGHT ve LIVING INTERNATIONAL çerçeveler için 3 modül çerçeveler – vidalı
○ LN4704	Diktörgen LIVINGLIGHT ve LIVING INTERNATIONAL çerçeveler için 4 modül çerçeveler – vidalı
○ LN4707	Diktörgen LIVINGLIGHT ve LIVING INTERNATIONAL çerçeveler için 7 modül çerçeveler – vidalı
○ LN4726	Diktörgen LIVINGLIGHT ve LIVING INTERNATIONAL çerçeveler için 3 + 3 modül çerçeveler – vidalı

Ref.	GEÇMELİ KURULUM-AIR
○ LN4702E	LNE... AIR çerçeveler için 2 modül kaide- tek başına, 2 + 2 ya da 2+2+2 modül olarak kullanılabilir.
Ref.	MODÜLER KURULUM-AIR
○ LN4702E	LNE.. AIR çerçeveler için 2 modül kaide
○ LN4702C	LNC.. AIR çerçeveler için 2 modül kaide – vidalı
○ LN4703C	LNC.. AIR çerçeveler için 3 modül kaide – vidalı
○ LN4704C	LNC.. AIR çerçeveler için 4 modül kaide – vidalı
○ LN4707C	LNC.. AIR çerçeveler için 7 modül kaide – vidalı
○ LN4726C	LNC.. AIR çerçeveler için 3+3 modül kaide – vidalı

## KORUMA KILIFLARI VE AKSESUARLAR



Ref.		<b>KAİDELER İÇİN KORUMA KILIFLARI</b>
○ LN4782		2 modül kaide ürünü ref. LN4702G ve LN4702 - alçılı sonlandırma işi için kullanılır.
○ LN4783		3 modül kaide ref. LN4703
○ LN4784		koruma kılıfı 4 modül kaide ürünü için ref. LN4704
○ LN4787		koruma kılıfı 7 modül kaide ürünü için ref. LN4707
○ LN4786		koruma kılıfı 3+3 modül kaide ürünü için ref. LN4726

Ref.		<b>SIVA ALTI BUAT KORUMA KAPAĞI</b>
○ 503CG		sıva altı buatlar için koruma kapağı (ref. 503E için)
○ 503EV		data ve güç devreleri için seperatör (ref. 503E için)
○ 503EC		ref. 503E için ön kapak, boyanabilir
○ 504EC		ref. 504E için ön kapak, boyanabilir
○ 506EC		ref. 506E için ön kapak, boyanabilir
○ 503DE		data ve güç devreleri için seperatör (ref. 504E için)
○ 503ED		ref. 502E, 503E ve 504E için yatay ve dikey birleştirme aparatı. 506L için dikey birleştirme aparatı (bu buat genişletme aksesuarı ile kullanılmaya uygun değildir)
○ 500/02		30mm'lik vida çifti, kaidelein buata montajı içindir.

Ref.		<b>PANÇ (DELME) MAKİNASI İÇİN AKSESUAR</b>
○ PBD68		yuvarlak tip alçıpan buatlarının montajında alçıpan duvarı kesmek için kullanılır. Panç makinasına takılır, çapı 68mm'dir.

## MODÜLER KURULUM AKSESUARLARI



Ref.		<b>BUAT GENİŞLETME AKSESUARI</b>
○ 503ESE		503E için derinlik artırıcı adaptör, buat genişletme aksesuarı
○ 504ESE		504E için derinlik artırıcı adaptör, buat genişletme aksesuarı
○ 506LSE		506L için derinlik artırıcı adaptör, buat genişletme aksesuarı
○ 506ESE		506E için derinlik artırıcı adaptör, buat genişletme aksesuarı

Buat içinde birden fazla kablo olması halinde, size alan yaratarak daha kolay kablolama imkanı sunar.

### BUAT GENİŞLETME AKSESUARI KULLANILMASI GEREKEN ÜRÜNLER (LIVINGLIGHT AIR İÇİN)

Buat genişletme	Ürünler	Ref.
10 A 2 modül	Rotatif VAVİEN anahtarlı dimmer - 1 modül	□ N4402N ■ NT4402N ■ L4402N
	Rezistif rotatif dimmer - 1 modül	□ N4406 ■ NT4406 ■ L4406
	Axial LIHT butonu + MyHOME arayüzü - 1 modül	□ N4055AN ■ NT4055AN ■ L4055AN
Axial LIHT butonu + MyHOME arayüzü - 2 modül		□ N4055M2AN ■ NT4055M2AN ■ L4055M2AN
	230 V AC. tıraş priz	□ N4177 ■ NT4177 ■ L4177

Ref.		<b>BUAT PLAKASI LIVINGLIGHT AIR İÇİN (3 MODÜL UYGULAMALARDA KULLANILIR)</b>
○ 503ESC		503E buatlarda kullanılır
○ 504ESC		504E buatlarda kullanılır
○ 506LSC		506L buatlarda kullanılır
○ 506ESC		506E buatlarda kullanılır

# OTEL ÇÖZÜMLERİ

Bu sayfadaki aygıtlar otel odalarının kullanımı içindir. Otel odaları ve resepsiyonlarda ihtiyaç duyulabilecek farklı uygulamalar için BTicino'nun zengin çözüm seçenekleri bulunmaktadır.



LN4549



L4177



NT4915TN



N4915SETBL



N4373H



NT4915DD



NT4915MR



N4547



N4028H



N4033

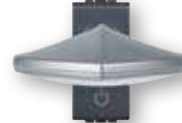

L4362

Ref.		<b>ENERGY SAVER</b>
○ LN4549		30 sn gecikmeli, 230 V AC, 2 modül, istenilen renkteki tuş kapakları ile tamamlanır.
○ LN4548		RFID Energy saver 30 sn gecikmeli, 230V AC, 2 modül istenilen renkteki tuş kapakları ile tamamlanır.

		<b>ENERGY SAVER TUŞ KAPAĞI</b>
<input type="checkbox"/> N4547 <input type="checkbox"/> NT4547 <input type="checkbox"/> L4547		geleneksel energy saver'lar ya da MyHOME energy saver'lar için tuş kapağı - kurulum sadece 2 modül buatlar ile yapılabilir.
<input type="checkbox"/> N4551 <input type="checkbox"/> NT4551 <input type="checkbox"/> L4551		Energy saver'lar için 3 modül tuş kapağı

		<b>SEMBOLLÜ TUŞ KAPAKLARI</b>
<input type="checkbox"/> N4915DD <input type="checkbox"/> NT4915DD <input type="checkbox"/> L4915DD		"Do not disturb" sembollü tuş kapağı
<input type="checkbox"/> N4915MR <input type="checkbox"/> NT4915MR <input type="checkbox"/> L4915MR		"Rearrange the room" sembollü tuş kapağı
<input type="checkbox"/> N4915M2DD <input type="checkbox"/> NT4915M2DD <input type="checkbox"/> L4915M2DD		"Do not disturb" sembollü 2 modül tuş kapağı

		<b>OTEL ÇAĞRI GÖSTERGE LAMBASI VE BUTONU</b>
<input type="checkbox"/> N4373H <input type="checkbox"/> NT4373H <input type="checkbox"/> L4373H		"Do not disturb" ve "Make-up the room" etiketli otel çağrı gösterge lambası - LN4742V12T (12 V) referanslı 2 adet Led ile kullanılır
<input type="checkbox"/> N4028H <input type="checkbox"/> L4028H		1P 16A - 250V AC enversör LIHT butonu 1-0-2 şeklinde çalışabilir - "PLEASE DO NOT DISTURB" ve "PLEASE MAKE UP THE ROOM" tuşları oda için istenilen durum doğrultusunda kullanılır.

Ref.		<b>KİŞİSELLEŞTİRİLEBİLEN TUŞ KAPAKLARI VE KİTLER</b>
<input type="checkbox"/> N4915TN <input type="checkbox"/> NT4915TN <input type="checkbox"/> L4915TN		kişiselleştirilebilir tuş kapağı - 1 modül
<input type="checkbox"/> N4915SETBL <input type="checkbox"/> NT4915SETBL <input type="checkbox"/> L4915SETBL		yatak başı ışık sembolü (50 adetlik kit)

		<b>TIRAŞ PRİZİ</b>
<input type="checkbox"/> N4177 <input type="checkbox"/> NT4177 <input type="checkbox"/> L4177		tıraş prizi 230 V AC. @ 50/60 Hz - 115/230 V AC 20 VA

		<b>LIHT BUTONU, KORDONLU</b>
<input type="checkbox"/> N4033 <input type="checkbox"/> NT4033 <input type="checkbox"/> L4033		kordonlu LIHT butonu 1 K NA 10 A

		<b>DİMLENEBİLİR OKUMA LAMBASI</b>
<input type="checkbox"/> N4362 <input type="checkbox"/> NT4362 <input type="checkbox"/> L4362		istenen açıyla basucundan yatağa doğru konumlandırılabilir. Aydınlatılmak istenen noktaya uzanabilmesi için esnek gövdeli olarak tasarlanmıştır. Aydınlatmayı istenen yoğunluğa getirmek için kontrol mekanizması aracılığıyla dimlenebilir. Aynı zamanda istendiği takdirde uzaktan kumanda ile de 30 sn basılarak uzaktan yönetilebilir. -Led ışıklı. -3W tüketim. - 110 lümen ışık yayılımı (15W akkora eşittir) - 40.000 saat süreklilik. -1 modül.

		<b>USB ŞARJ PRİZLERİ</b>
<input type="checkbox"/> N4285C1 <input type="checkbox"/> NT4285C1 <input type="checkbox"/> L4285C1		USB prizi 5 V DC akıllı telefon, tablet ve benzeri elektronik aletleri şarj etmek için kullanılır. 1 A- 230 V AC.
<input type="checkbox"/> N4285C2 <input type="checkbox"/> NT4285C2 <input type="checkbox"/> L4285C2		USB prizi 5 V DC akıllı telefon, tablet ve benzeri elektronik aletleri şarj etmek için kullanılır. Tek cihazda 2400mA, iki cihazda ise cihaz başına 1200mA şarj akımı sağlar.



# ÇERÇEVELER VE KURULUM

# GEÇMELİ KURULUM

## Dikdörtgen çerçeveler

Buatlar

Kaideler

Modül sayısı

Çerçeveler

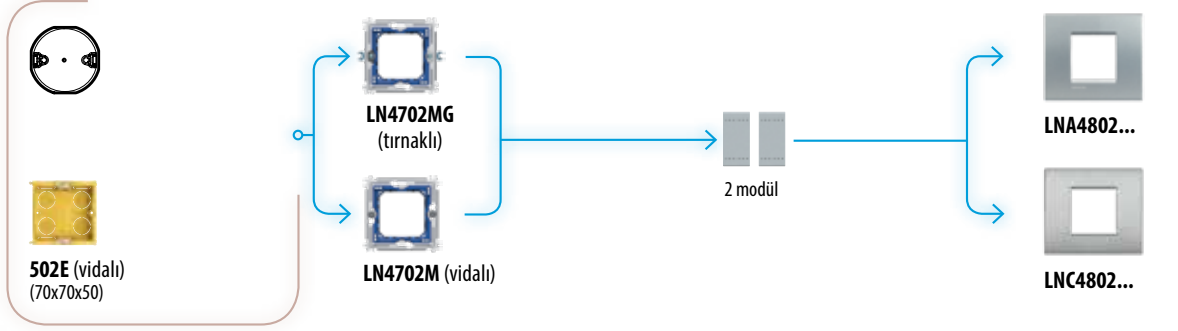

YATAY KURULUM  
MERKEZ ARALIĞI 71 mm

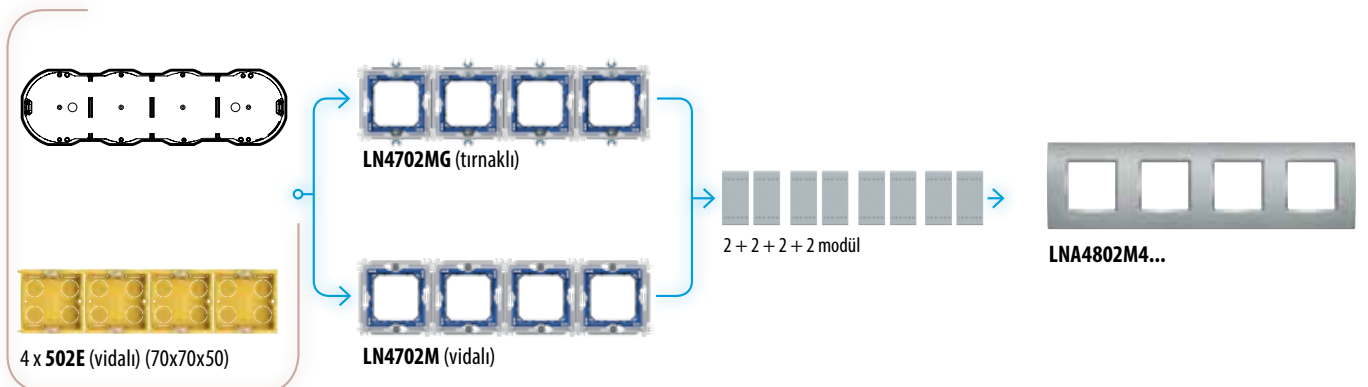
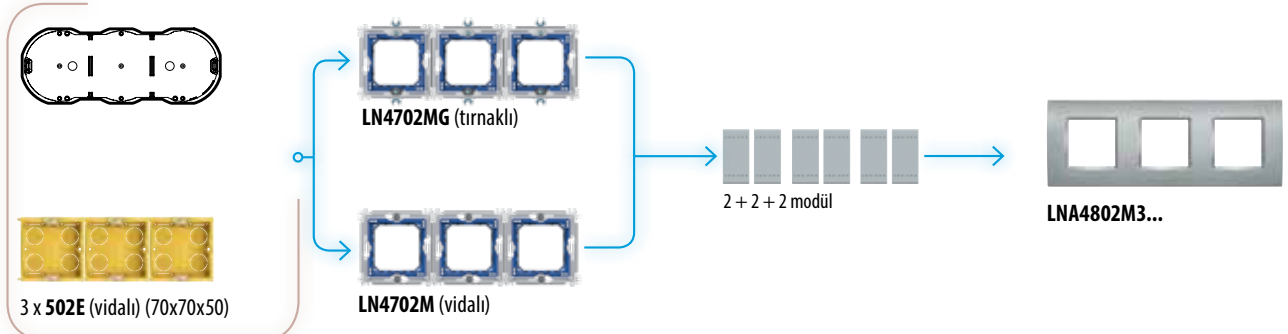
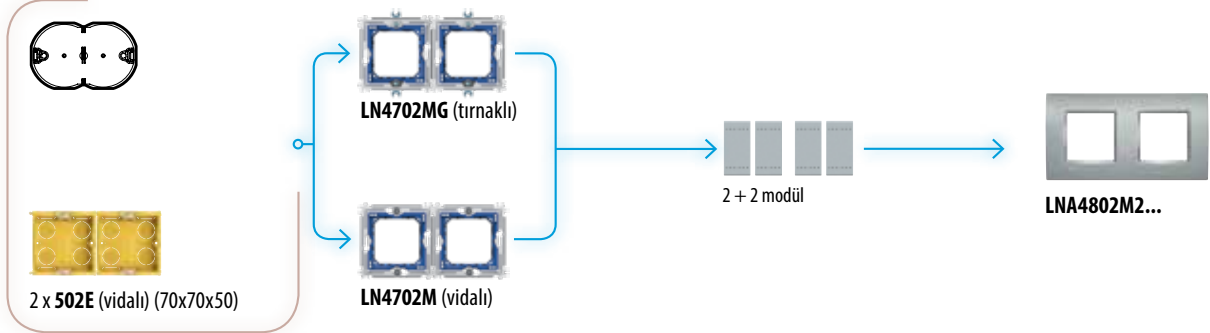



Buatlar

DIKEY KURULUM  
MERKEZ ARALIĞI 71 mm



Kaideler

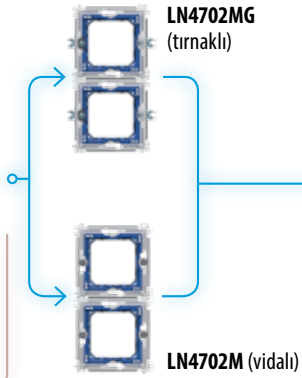

Modül sayısı





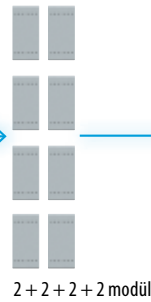
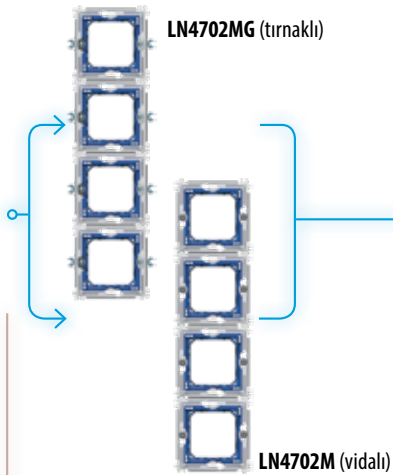
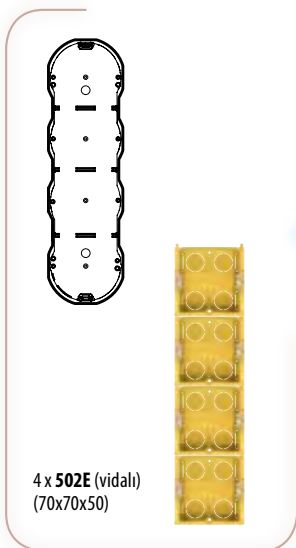
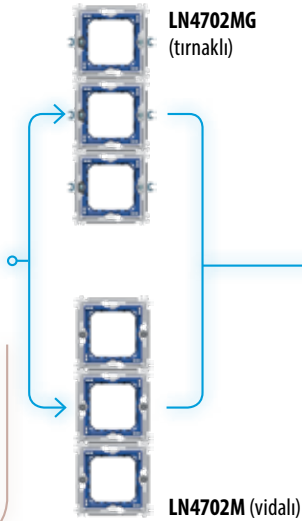
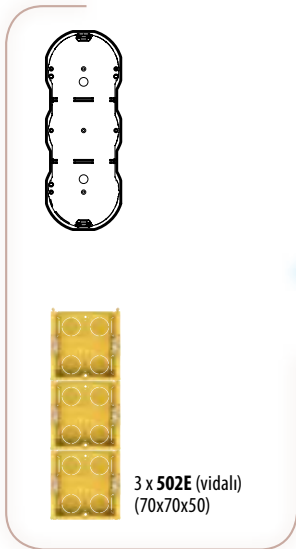







Çerçeveser



# GEÇMELİ KURULUM

## Dikdörtgen çerçeve renkleri

<b>METAL</b> Malzeme: zamak	 Altın - OA	 Bronz - BZ	 Nikel - NS
<b>DOĞAL</b> Malzeme: zamak	 Zamak - NA	 Gümüş - AG	 Satine çelik - ACS
<b>İPEK</b> Malzeme: zamak	 Park - PK	 Toprak - SQ	 Kiremit - RK
	 Kum - AE	 Mor - CB	

### DİKDÖRTGEN ÇERÇEVE KODLAR

2 modül - LNA4802...

2+2 modül - merkezler arası 71 mm - LNA4802M2...

2+2+2 modül - merkezler arası 71 mm - LNA4802M3...

2+2+2+2 modül - merkezler arası 71 mm - LNA4802M4...

**SAYDAM**

Malzeme: polimer plastik



Turkuaz - VD



Turuncu - OD



Mavi - AD

**KRİSTAL**

Malzeme: polimer plastik



Sis - KF



Akvamarin - KA



Buz grisi - KG

**NÖTR**

Malzeme: polimer plastik



Antrasit - AR



Beyaz - BI



Alüminyum - TE

**AHŞAP**

Malzeme: yeşil çam ağacı



Kiraz ağacı - LCA

























Bambu - LBA



Ceviz ağacı - LNC

# GEÇMELİ KURULUM

## Dikdörtgen çerçeveler: seçim tablosu

MODÜL					
		2	2+2 Merkez aralığı 71 mm	2+2+2 Merkez aralığı 71 mm	2+2+2+2 Merkez aralığı 71 mm
<b>METAL (zamak)</b>					
	Altın	LNA48020A	LNA4802M20A	LNA4802M30A	LNA4802M40A
	Bronz	LNA4802BZ	LNA4802M2BZ	LNA4802M3BZ	LNA4802M4BZ
	Nikel	LNA4802NS	LNA4802M2NS	LNA4802M3NS	LNA4802M4NS
<b>DOĞAL (zamak)</b>					
	Zamak	LNA4802NA	LNA4802M2NA	LNA4802M3NA	LNA4802M4NA
	Gümüş	LNA4802AG	LNA4802M2AG	LNA4802M3AG	LNA4802M4AG
	Satine çelik	LNA4802ACS	LNA4802M2ACS	LNA4802M3ACS	LNA4802M4ACS
<b>İPEK (zamak)</b>					
	Park	LNA4802PK	LNA4802M2PK	LNA4802M3PK	LNA4802M4PK
	Toprak	LNA4802SQ	LNA4802M2SQ	LNA4802M3SQ	LNA4802M4SQ
	Kiremit	LNA4802RK	LNA4802M2RK	LNA4802M3RK	LNA4802M4RK
	Kum	LNA4802AE	LNA4802M2AE	LNA4802M3AE	LNA4802M4AE
	Mor	LNA4802CB	LNA4802M2CB	LNA4802M3CB	LNA4802M4CB
<b>SAYDAM (polimer plastik)</b>					
	Yeyil	LNA4802VD	LNA4802M2VD	LNA4802M3VD	LNA4802M4VD
	Turuncu	LNA4802OD	LNA4802M2OD	LNA4802M3OD	LNA4802M4OD
	Mavi	LNA4802AD	LNA4802M2AD	LNA4802M3AD	LNA4802M4AD
<b>KRİSTAL (polimer plastik)</b>					
	Sis	LNA4802KF	LNA4802M2KF	LNA4802M3KF	LNA4802M4KF
	Akvamarin	LNA4802KA	LNA4802M2KA	LNA4802M3KA	LNA4802M4KA
	Buz grisi	LNA4802KG	LNA4802M2KG	LNA4802M3KG	LNA4802M4KG
<b>NÖTR (polimer plastik)</b>					
	Antrasit	LNA4802AR	LNA4802M2AR	LNA4802M3AR	LNA4802M4AR
	Beyaz	LNA4802BI	LNA4802M2BI	LNA4802M3BI	LNA4802M4BI
	Alüminyum	LNA4802TE	LNA4802M2TE	LNA4802M3TE	LNA4802M4TE
<b>AHŞAP (yekpare ağaç)</b>					
	Kiraz ağacı	LNA4802LCA	LNA4802M2LCA	LNA4802M3LCA	LNA4802M4LCA
	Bambu	LNA4802LBA	LNA4802M2LBA	LNA4802M3LBA	LNA4802M4LBA
	Ceviz ağacı	LNA4802LNC	LNA4802M2LNC	LNA4802M3LNC	LNA4802M4LNC
<b>KAİDELER</b>					
	Vidalı	LN4702M	LN4702M (x2)	LN4702M (x3)	LN4702M (x4)
	Tırmaklı	LN4702MG	LN4702MG (x2)	LN4702MG (x3)	LN4702MG (x4)
	Vidalı (plastik)	LN4702	LN4702 (x2)	LN4702 (x3)	LN4702 (x4)
	Tırmaklı (plastik)	LN4702G	LN4702G (x2)	LN4702G (x3)	LN4702G (x4)

# LIVINGLIGHT AIR - GEÇMELİ KURULUM

## Çerçeve kurulumu

Buatlar

Kaideler

Modül sayısı

Çerçeveler

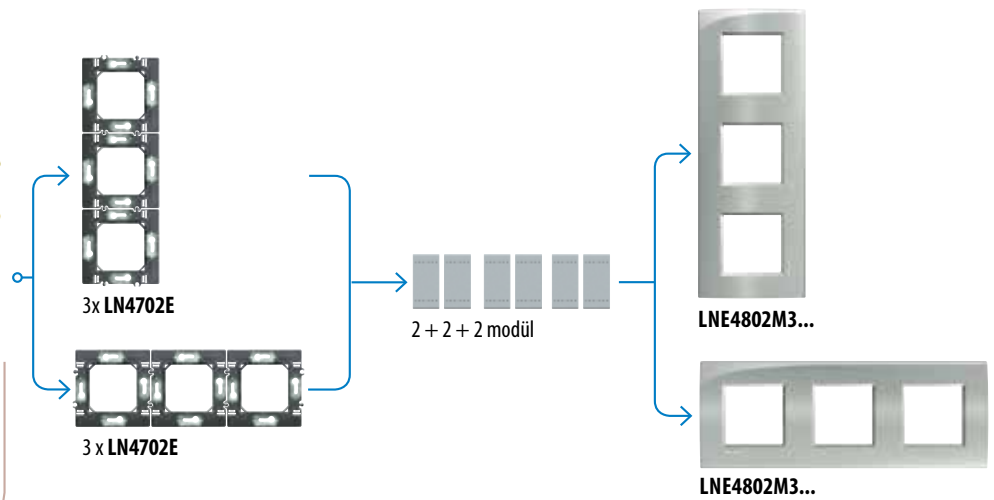
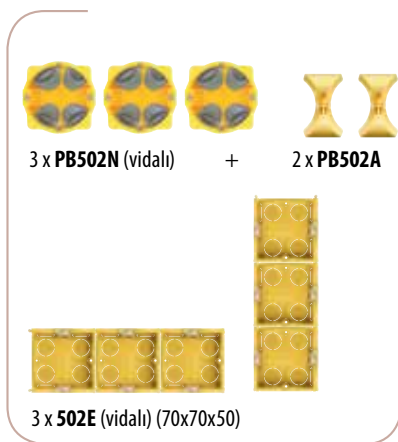
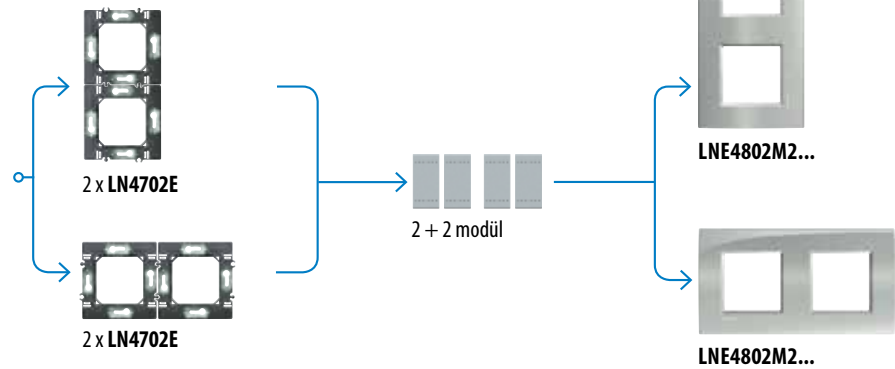
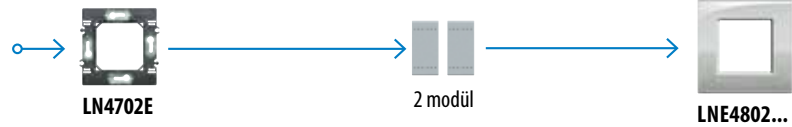

# LIVINGLIGHT AIR

Çerçeve renkleri

MONOKROM

Malzeme: zamak



Beyaz - BN



Alüminyum - TE



Antrasit - AR

YUMUŞAK - SOFT

Malzeme: zamak



YENİ

Füme - ST



YENİ

Toprak - CY



YENİ

Kum - SB



YENİ

Mavi ay - BM



# LIVINGLIGHT AIR

## Çerçeve renkleri

FIRÇALI  
Malzeme: zamak



YENİ

Nikel - NIS



YENİ

Titanyum - TIS



YENİ

Krom - CRS

PARLAK  
Malzeme: zamak



Çelik - PT



Krom - PL



Mat altın - OF



Mat nikel - NK

















İnci beyazı - PR

# LIVINGLIGHT AIR

## Çerçeveler: seçim tablosu

### Modül

	3	4	7	3+3	
<b>MONOKROM (zamak)</b>					
	Beyaz - BN	LNC4803BN	LNC4804BN	LNC4807BN	LNC4826BN
	Alüminyum - TE	LNC4803TE	LNC4804TE	LNC4807TE	LNC4826TE
	Antrasit - AR	LNC4803AR	LNC4804AR	LNC4807AR	LNC4826AR
<b>YUMUŞAK - SOFT (zamak)</b>					
	Füme - ST	LNC4803ST	LNC4804ST	LNC4807ST	LNC4826ST
	Toprak - CY	LNC4803CY	LNC4804CY	LNC4807CY	LNC4826CY
	Kum - SB	LNC4803SB	LNC4804SB	LNC4807SB	LNC4826SB
	Mavi ay - BM	LNC4803BM	LNC4804BM	LNC4807BM	LNC4826BM
<b>PARLAK (zamak)</b>					
	Çelik - PT	LNC4803PT	LNC4804PT	LNC4807PT	LNC4826PT
	Krom - PL	LNC4803PL	LNC4804PL	LNC4807PL	LNC4826PL
	Mat altın - OF	LNC4803OF	LNC4804OF	LNC4807OF	LNC4826OF
	Mat nikel - NK	LNC4803NK	LNC4804NK	LNC4807NK	LNC4826NK
	İnci beyazı - PR	LNC4803PR	LNC4804PR	LNC4807PR	LNC4826PR
<b>FIRÇALI (zamak)</b>					
	Nikel - NIS	LNC4803NIS	LNC4804NIS	LNC4807NIS	LNC4826NIS
	Titanyum - TIS	LNC4803TIS	LNC4804TIS	LNC4807TIS	LNC4826TIS
	Krom - CRS	LNC4803CRS	LNC4804CRS	LNC4807CRS	LNC4826CRS
<b>Kaide</b>					
Kaide	LN4703C	LN4704C	LN4707C	LN4726C	

## Çerçeveler: seçim tablosu















### AIR ÇERÇEVE KODLARI

2 modül - LNE4802...

2 + 2 modül - LNE4802M2...

2 + 2 + 2 modül - LNE4802M3...

### Modül

	2	2+2	2+2+2	
<b>MONOKROM (zamak)</b>				
	<b>Beyaz - BN</b>	<b>LNE4802BN</b>	<b>LNE4802M2BN</b>	<b>LNE4802M3BN</b>
	<b>Alüminyum - TE</b>	<b>LNE4802TE</b>	<b>LNE4802M2TE</b>	<b>LNE4802M3TE</b>
	<b>Antrasit - AR</b>	<b>LNE4802AR</b>	<b>LNE4802M2AR</b>	<b>LNE4802M3AR</b>
<b>YUMUŞAK - SOFT (zamak)</b>				
	<b>Füme - ST</b>	<b>LNE4802ST</b>	<b>LNE4802M2ST</b>	<b>LNE4802M3ST</b>
	<b>Toprak - CY</b>	<b>LNE4802CY</b>	<b>LNE4802M2CY</b>	<b>LNE4802M3CY</b>
	<b>Kum - SB</b>	<b>LNE4802SB</b>	<b>LNE4802M2SB</b>	<b>LNE4802M3SB</b>
	<b>Mavi ay - BM</b>	<b>LNE4802BM</b>	<b>LNE4802M2BM</b>	<b>LNE4802M3BM</b>
<b>PARLAK (zamak)</b>				
	<b>Çelik - PT</b>	<b>LNE4802PT</b>	<b>LNE4802M2PT</b>	<b>LNE4802M3PT</b>
	<b>Krom - PL</b>	<b>LNE4802PL</b>	<b>LNE4802M2PL</b>	<b>LNE4802M3PL</b>
	<b>Mat altın - OF</b>	<b>LNE4802OF</b>	<b>LNE4802M2OF</b>	<b>LNE4802M3OF</b>
	<b>Mat nikel - NK</b>	<b>LNE4802NK</b>	<b>LNE4802M2NK</b>	<b>LNE4802M3NK</b>
	<b>İnci beyazı - PR</b>	<b>LNE4802PR</b>	<b>LNE4802M2PR</b>	<b>LNE4802M3PR</b>
<b>FIRÇALI (zamak)</b>				
	<b>Nikel - NIS</b>	<b>LNE4802NIS</b>	<b>LNE4802M2NIS</b>	<b>LNE4802M3NIS</b>
	<b>Titanyum - TIS</b>	<b>LNE4802TIS</b>	<b>LNE4802M2TIS</b>	<b>LNE4802M3TIS</b>
	<b>Krom - CRS</b>	<b>LNE4802CRS</b>	<b>LNE4802M2CRS</b>	<b>LNE4802M3CRS</b>
<b>Kaide</b>				
<b>Kaide</b>	<b>LN4702E</b>	<b>2 x LN4702E</b>	<b>3 x LN4702E</b>	

# Çerçevelerinizi zevkinize göre özelleştirin

## KULLANIM ÖNERİSİ.

Living Light AIR beyaz çerçeve BN boyanabilir özelliktedir.

### BOYAMA

Beyaz çerçeve astar boya gibi kullanılabilir.  
Boyamadan önce yüzeyi temizleyin. Su bazlı boya kullanılabilir.

### Notlar

- Mekanizmaları (çerçeve içindeki anahtar, priz vb.) boyamayınız.
- Çerçeveyi ayrıca boyayın ve montajı kurduktan yapın.

### TEMİZLİK

Yalnızca nemli bir bez ile silin. Diğer temizlik ürünleri yüzeye zarar verebilir.

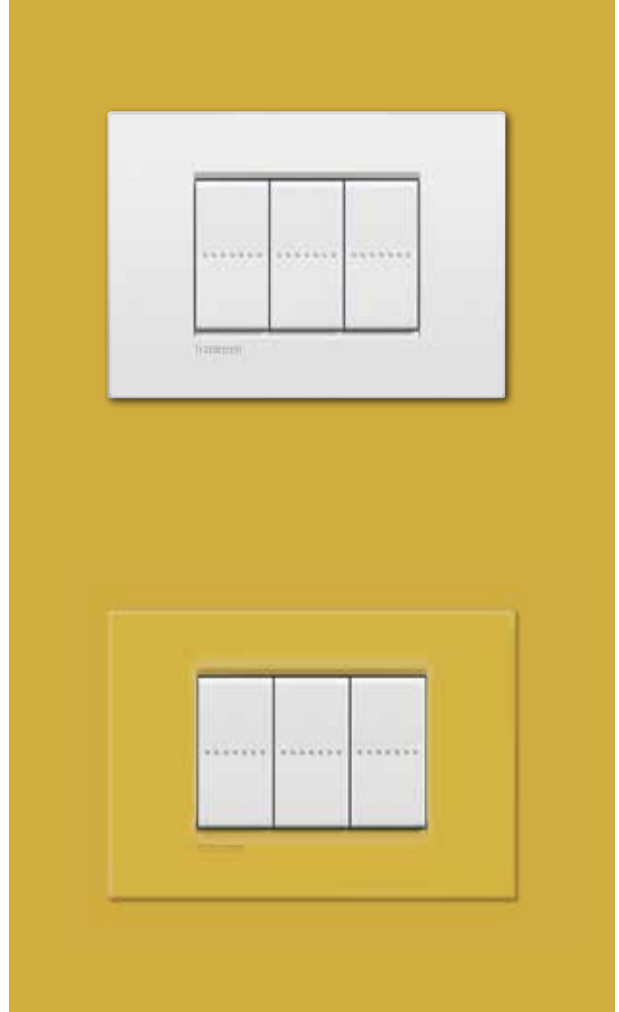

Beyaz BN çerçeve boyanabilir özelliktedir.

# LIVINGLIGHT MODÜLER KURULUM SİSTEMİ

Buatlar

Kaideler

Modül sayısı

Çerçeveler

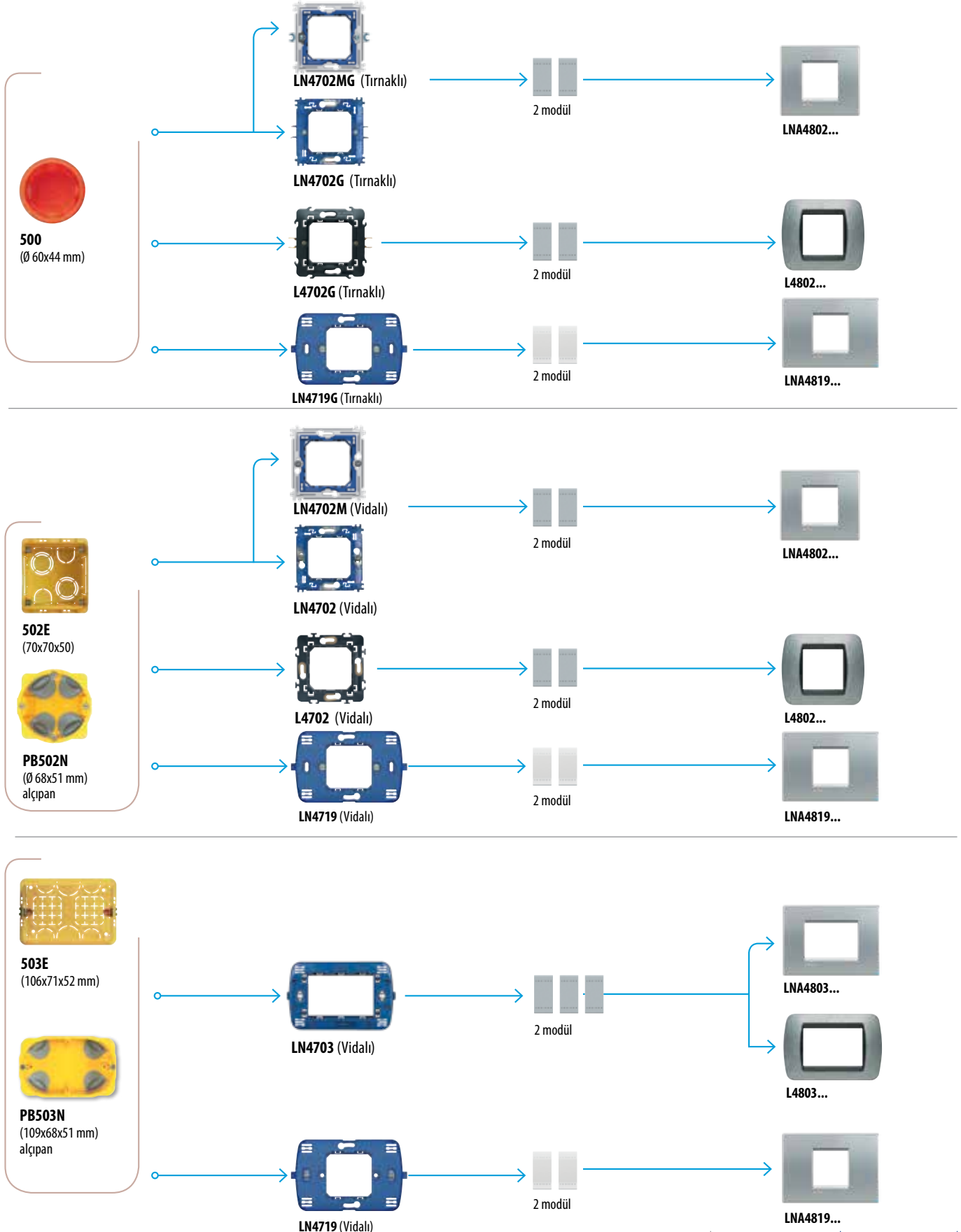

## Buatlar

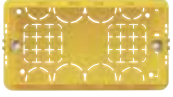

**504E**  
(133x74x53,5 mm)



**PB504N**  
(131,5x68x51 mm)  
alçıpan

## Kaideler



**LN4704 (Vidalı)**

## Modül sayısı



4 modül

## Çerçeveler



**LNA4804...**



**L4804...**

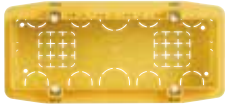

**506L**  
(183,5x90x53,5 mm)



**PB506N**  
(182x68x51 mm)  
alçıpan



**LN4707 (Vidalı)**



7 modül



**LNA4807...**



**L4807...**

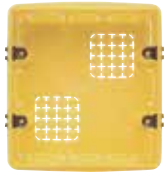

**506E**  
(106x117x52 mm)



**PB526N**  
(109x114x51 mm)  
alçıpan

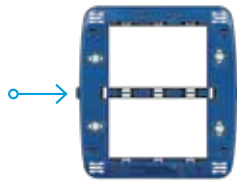

**LN4726 (Vidalı)**



3 + 3 modül



**LNA4826...**



**L4826...**













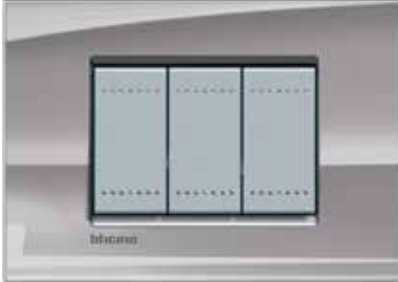

aksesuar ile temin edilir

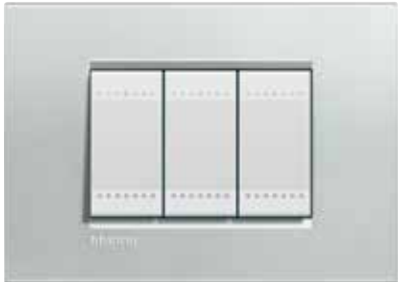
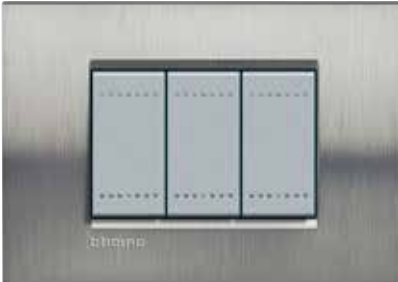

# LIVINGLIGHT - MODÜLER KURULUM SİSTEMİ

Dikdörtgen çerçeve renkleri

METAL Malzeme: zamak				
	<p>Altın - OA</p>	<p>Bronz - BZ</p>	<p>Nikel - NS</p>	
				
	<p>Çelik - AC</p>	<p>Ayışığı - GL</p>		
	DOĞAL Malzeme: zamak			
		<p>Zamak - NA</p>	<p>Gümüş - AG</p>	<p>Satine çelik - ACS</p>
İPEK Malzeme: zamak				
	<p>Park - PK</p>	<p>Toprak - SQ</p>	<p>Kiremit - RK</p>	
				
	<p>Kum - AE</p>	<p>Mor - CB</p>		

**DİKDÖRTGEN ÇERÇEVE ÜRÜN REFERANSLARI**

- 2 modül - LNA4802...
- 3 modül - LNA4803...
- 4 modül - LNA4803...
- 7 modül - LNA4807...
- 3+3 modül - LNA4826...

**SAYDAM**

Malzeme: polimer plastik



Turkuaz - VD



Turuncu - OD

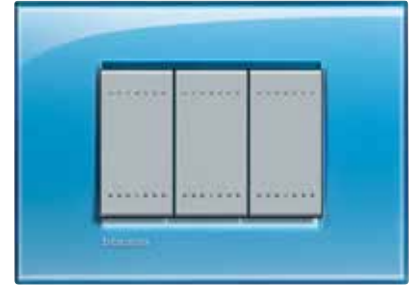

Mavi - AD

**KRISTAL**

Malzeme: polimer plastik



Sis - KF



Akvamarin - KA



Buz grisi - KG

**NÖTR**

Malzeme: polimer plastik



Antrasit - AR



Beyaz - BI



Alüminyum - TE

**AHŞAP**

Malzeme: yekpare ağaç



Kiraz ağacı - LCA



Bambu - LBA

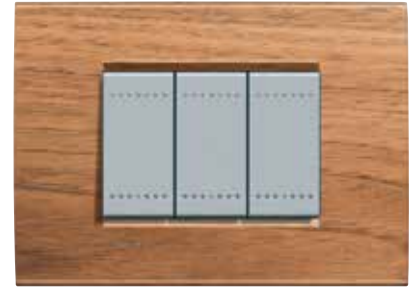

Ceviz ağacı - LNC

# LIVINGLIGHT - MODÜLER KURULUM SİSTEMİ

## Dikdörtgen çerçeveler: seçim tablosu

		MODÜL					
		2	2 merkezi	3	4	7	3+3
<b>METAL (zamak)</b>							
	Altın	LNA48020A	LNA48190A	LNA48030A	LNA48040A	LNA48070A	LNA48260A
	Bronz	LNA4802BZ	LNA4819BZ	LNA4803BZ	LNA4804BZ	LNA4807BZ	LNA4826BZ
	Nikel	LNA4802NS	LNA4819NS	LNA4803NS	LNA4804NS	LNA4807NS	LNA4826NS
	Çelik	LNA4802AC	LNA4819AC	LNA4803AC	LNA4804AC	LNA4807AC	LNA4826AC
	Moolight silver	LNA4802GL	LNA4819GL	LNA4803GL	LNA4804GL	LNA4807GL	LNA4826GL
<b>DOĞAL (zamak)</b>							
	Zamak	LNA4802NA	LNA4819NA	LNA4803NA	LNA4804NA	LNA4807NA	LNA4826NA
	Gümüş	LNA4802AG	LNA4819AG	LNA4803AG	LNA4804AG	LNA4807AG	LNA4826AG
	Satine çelik	LNA4802ACS	LNA4819ACS	LNA4803ACS	LNA4804ACS	LNA4807ACS	LNA4826ACS
<b>İPEK (zamak)</b>							
	Park	LNA4802PK	LNA4819PK	LNA4803PK	LNA4804PK	LNA4807PK	LNA4826PK
	Toprak	LNA4802SQ	LNA4819SQ	LNA4803SQ	LNA4804SQ	LNA4807SQ	LNA4826SQ
	Kiremit	LNA4802RK	LNA4819RK	LNA4803RK	LNA4804RK	LNA4807RK	LNA4826RK
	Kum	LNA4802AE	LNA4819AE	LNA4803AE	LNA4804AE	LNA4807AE	LNA4826AE
	Mor	LNA4802CB	LNA4819CB	LNA4803CB	LNA4804CB	LNA4807CB	LNA4826CB
<b>SAYDAM (polimer plastik)</b>							
	Yeşil	LNA4802VD	LNA4819VD	LNA4803VD	LNA4804VD	LNA4807VD	LNA4826VD
	Turuncu	LNA4802OD	LNA4819OD	LNA4803OD	LNA4804OD	LNA4807OD	LNA4826OD
	Mavi	LNA4802AD	LNA4819AD	LNA4803AD	LNA4804AD	LNA4807AD	LNA4826AD
<b>KRİSTAL (polimer plastik)</b>							
	Sis	LNA4802KF	LNA4819KF	LNA4803KF	LNA4804KF	LNA4807KF	LNA4826KF
	Akvamarin	LNA4802KA	LNA4819KA	LNA4803KA	LNA4804KA	LNA4807KA	LNA4826KA
	Bus grisi	LNA4802KG	LNA4819KG	LNA4803KG	LNA4804KG	LNA4807KG	LNA4826KG
<b>NÖTR (polimer plastik)</b>							
	Antrasit	LNA4802AR	LNA4819AR	LNA4803AR	LNA4804AR	LNA4807AR	LNA4826AR
	Beyaz	LNA4802BI	LNA4819BI	LNA4803BI	LNA4804BI	LNA4807BI	LNA4826BI
	Alüminyum	LNA4802TE	LNA4819TE	LNA4803TE	LNA4804TE	LNA4807TE	LNA4826TE
<b>AHŞAP</b>							
	Kiraz ağacı	LNA4802LCA	LNA4819LCA	LNA4803LCA	LNA4804LCA	LNA4807LCA	LNA4826LCA
	Bambu	LNA4802LBA	LNA4819LBA	LNA4803LBA	LNA4804LBA	LNA4807LBA	LNA4826LBA
	Ceviz ağacı	LNA4802LNC	LNA4819LNC	LNA4803LNC	LNA4804LNC	LNA4807LNC	LNA4826LNC
<b>KAİDELER</b>							
	Vidalı	LN4702	LN4719	LN4703	LN4704	LN4707	LN4726
	Tırnaklı	LN4702G	LN4719G				

# LIVING INTERNATIONAL - MODÜLER KURULUM SİSTEMİ

## Çerçeve renkleri

### METAL

Malzeme : zama k



Açık alüminyum-AL



Koyu çelik - AC



Açık titanyum-TC

### PARLAK

Malzeme : zama k

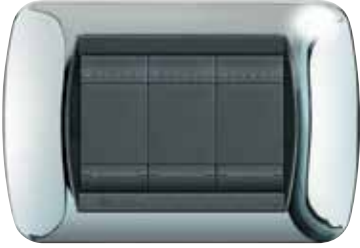

Parlak krom - CR



Altın - OR

### ÖZEL

Malzeme : zama k



Satine çelik - ACS



Grafit - GF



Siyah grafit - GFN

#### LIVING INTERNATIONAL ÇERÇEVE REFERANSLARI

- 2 modül - L4802...
- 3 modül - L4803...
- 4 modül - L4804...
- 7 modül - L4807...
- 3+3 modül - L4826...

**TEKNOLOJİK**

Malzeme: zamak



Alüminyum - TE

**POLİMER**

Malzeme: plastik



Koyu çelik - PA\*



Beyaz - PB\*



Tam beyaz - BI\*

\* 3+3 modül seçeneği olmayan çerçeve modelleri

**LIVING INTERNATIONAL: seçim tablosu**
**MODÜL**

		2	3	4	7	3 + 3
<b>METAL (zamak)</b>						
	Açık alüminyum	L4802AL	L4803AL	L4804AL	L4807L	L4826AL
	Koyu çelik	L4802AC	L4803AC	L4804AC	L4807C	L4826AC
	Açık titanyum	L4802TC	L4803TC	L4804TC	L4807TC	L4826TC
<b>PARLAK (zamak)</b>						
	Parlak krom	L4802CR	L4803CR	L4804CR	L4807CR	L4826CR
	Altın	L4802OR	L4803OR	L4804OR	L4807OR	L4826OR
<b>ÖZEL (zamak)</b>						
	Satine çelik	L4802ACS	L4803ACS	L4804ACS	L4807ACS	L4826ACS
	Grafit	L4802GF	L4803GF	L4804GF	L4807GF	L4826GF
	Siyah grafit	L4802GFN	L4803GFN	L4804GFN	L4807GFN	L4826GFN
<b>TEKNOLOJİK (zamak)</b>						
	Alüminyum	L4802TE	L4803TE	L4804TE	L4807TE	L4826TE
<b>POLİMER (plastik)</b>						
	Koyu çelik	L4802PA	L4803PA	L4804PA	L4807PA	
	Beyaz	L4802PB	L4803PB	L4804PB	L4807PB	
	Tam beyaz	L4802BI	L4803BI	L4804BI	L4807BI	

**KAİDELER**

Kaideler	L4702-L4702G	LN4703	LN4704	LN4707	LN4726
----------	--------------	--------	--------	--------	--------

# LIVING LIGHT<sup>AIR</sup> - MODÜLER KURULUM SİSTEMİ

Buatlar

Kaideler

Modül sayısı

AIR çerçeveler



**502W**  
(70.5x70.5x58)



**502E**  
(70.5x70.5x58 mm)  
alçıpan



**LN4702C** vidalı



2 modül



**LNC4802...**

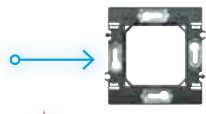

**LN4702E**



2 modül



**LNE4802...**

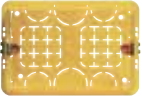

**503E**  
(106x71x52 mm)



**PB503N**  
(109x68x51 mm)  
alçıpan



**LN4703C** vidalı



3 modül



**LNC4803...**

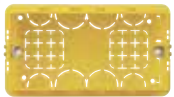

**504E**  
(133x74x53.5 mm)



**PB504N**  
(131.5x68x51 mm)  
alçıpan



**LN4704C** vidalı



4 modül



**LNC4804...**

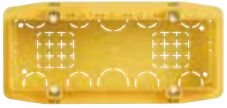

**Buatlar****506L**  
(183.5x90x53.5 mm)**PB506N**  
(182x68x51 mm)  
alçıpan**Kaideler****LN4707C** vidalı**Modül sayısı**

7 modül

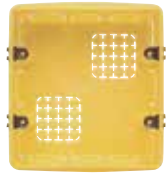
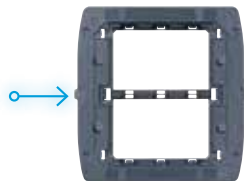
**AIR çerçeveler****LNC4807...****506E**  
(106x117x52 mm)**PB526N**  
(109x114x51 mm)  
alçıpan**LN4726C** with vidalı

aksesuar ile temin edilir

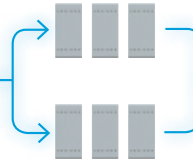

3 + 3 modül



**LNC4826...**

# KİŞİSELLEŞTİRİLEBİLİR AYDINLATMA NOKTASI







Transparan tuş kapakları 2, 3, 4, 7, 2+2, 2+2+2 ve 3+3 modül transparan çerçeveler, anahtar&prizlerinizi zevkinize göre kişiselleştirebilme fırsatı sunar. Anahtar&prizlerinizin duvar kağıdına uyumlu halde olmasını arzu ediyorsanız, duvar hizasına yerleştireceğiniz alt çerçevenin üstüne duvar kağıdınızdan yerleştirip üzerine transparan çerçeveyi monte ediniz.

## STANDART ANAHTARLAR İÇİN

### kişiselleştirilebilir tuş kapakları

Ref.		
○ N4932		1 modül
○ N4932/2		2 modül
○ N4932/3		3 modül

### kişiselleştirilebilir transparan çerçeveler

○ LND4802KR		2 modül
○ LND4819KR		2 merkezi modül (LN4719 or LN4719G)
○ LND4803KR		3 modül
○ LND4804KR		4 modül
○ LND4807KR		7 modül
○ LND4826KR		3 + 3 modül



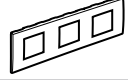



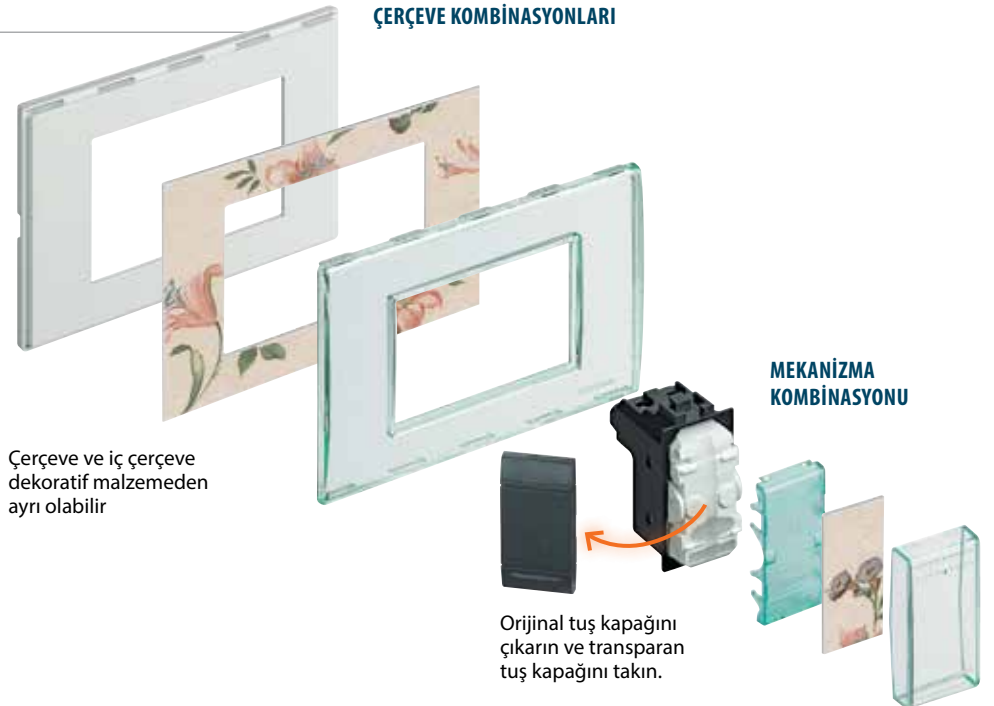













○ LND4802M2KR		71mm aralıklı 2 + 2 modül
○ LND4802M3KR		71mm aralıklı 2 + 2 + 2 modül

## ÇERÇEVE KOMBİNASYONLARI



# SIVA ÜSTÜ UYGULAMA

Sıva üstü buatlar	Modül	Çerçeveseler
 <p><b>502BI</b> (beyaz)</p>	 <p>2 modül</p>	 <p><b>LNA4802...</b></p>
 <p><b>503BI</b> (beyaz)</p>	 <p>3 modül</p>	 <p><b>LNA4803...</b></p>  <p><b>LNC4803...</b></p>
 <p><b>504BI</b> (beyaz)</p>	 <p>4 modül</p>	 <p><b>LNA4804...</b></p>  <p><b>LNC4804...</b></p>
 <p><b>502LP</b> kaideli (93x80x38)</p>	 <p>2 modül</p>	 <p><b>L4802...</b></p>
 <p><b>503LP</b> kaideli (120x80x38)</p>	 <p>3 modül</p>	 <p><b>L4803...</b></p>
 <p><b>504LP</b> kaideli (140x80x38)</p>	 <p>4 modül</p>	 <p><b>L4804...</b></p>

# IP55 ÇERÇEVELERİN SIVA ALTI BUATLARA KURULUMU

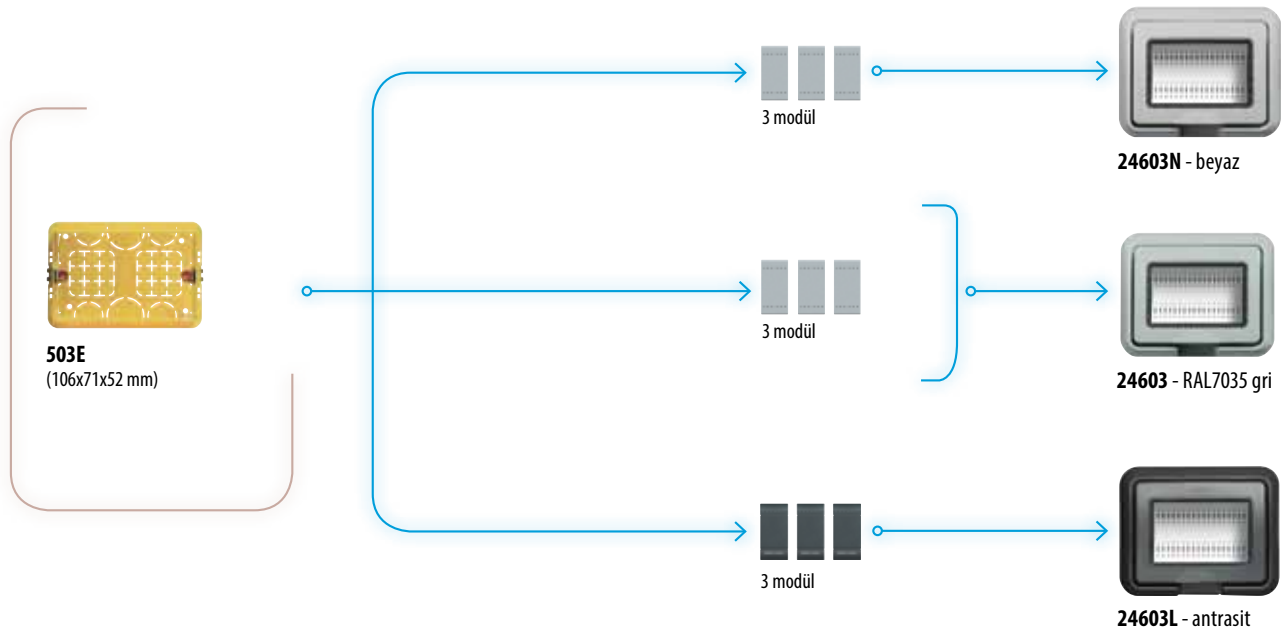
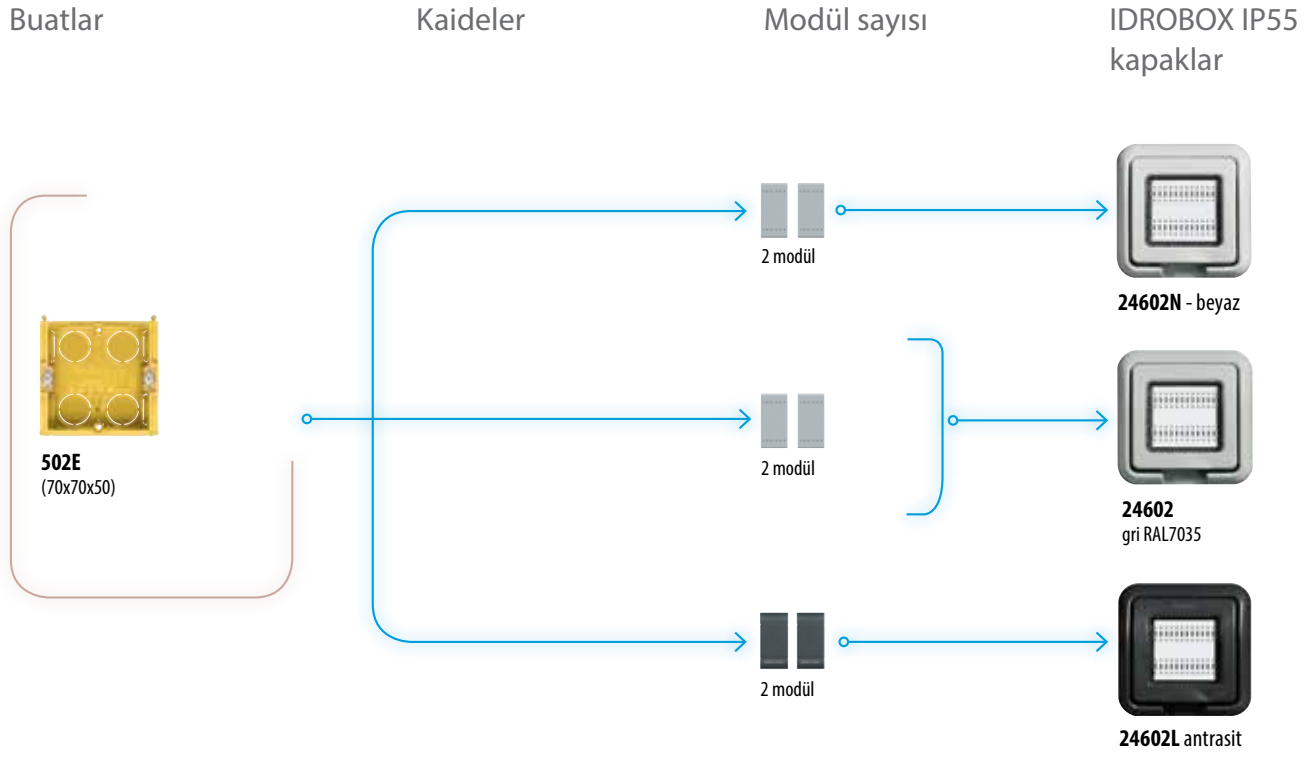

Buatlar

Kaideler

Modül sayısı

IDROBOX IP55 kapaklar

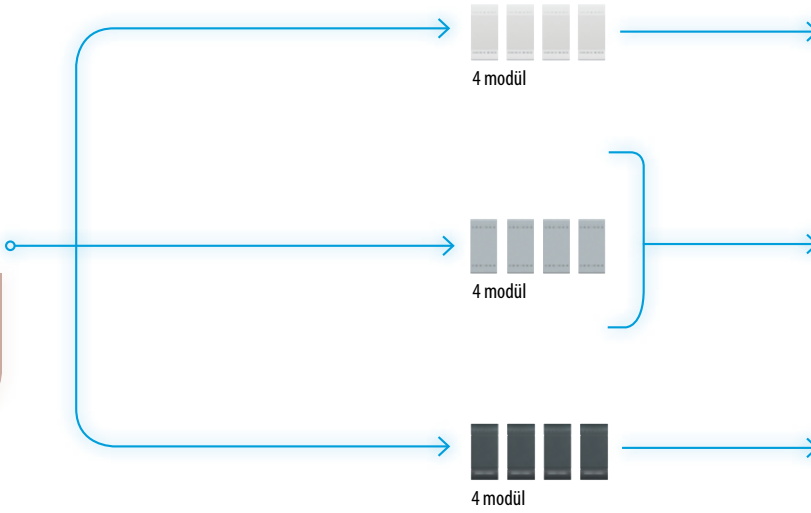

**24604N** - beyaz



**24604** - RAL7035 gri



**24604L** - antrasit

## IP40 VE IP55 SIVA ÜSTÜ KURULUM

### IP40 VE IP55 IDROBOX

IP40

IP40  
1 modül



**24401**

IP40  
2 modül



**24402**

IP40  
3 modül



**24403**

IP40  
4 modül



**24404**

IP40

IP40  
4 modül



**24404/2**

IP40  
6 modül



**24406**

IP55

IP55 Idrobox  
1 modül



**24501**

IP55 Idrobox  
2 modül



**24502**

IP55 Idrobox  
3 modül



**24503**

IP55 Idrobox  
4 modül



**24504**

# KORUMALI EVLERDE VE DİĞERLERİNDE KURULUM



25700

25700F/16  
25700F/20









150560F  
Yükseltilmiş zemin için  
kesici



150560SB  
Çimento zemin için buat



Item	IP40 İÇİN AKSESUARLAR
○ 25700	 bükülebilir kablo girişi contası Ø 5 - 14-16-20 mm – IP55
○ 25700F/16	 hızlı bağlantı boru contası Ø 16 mm
○ 25700F/20	 hızlı kuplaj boru contası Ø 20 mm
○ 25701	 yatay parça
○ 25701V	 dikey parça
○ 25702	 toprak bağlantısı için dahili terminal

Ref.	AKSESUAR BAĞLANTISI - DÖŞEME ALTI BUATLARI
	bu döşeme altı buatları 1 ya da 2 aksesuar bağlantısı modül cihazlar serisi LIVINGLIGHT için planlanmıştır. Kauçuktan yapılmış dayanak noktası ve otomatik kapanma özelliği sayesinde üstün koruma sağlar. 2 adet ayakla üzerine basılabilir şekilde monte edilen bu cihazlar: Paslanmaz çelik ve piriçten yapılan piriç kaplanmış şekilde ve aynı zamanda maksimum 500 kg. taşıyacak şekilde cilalanmıştır. Bu iki spesifik kutu istek üzerine çimento zemine ya da yükseltilmiş zemine monte edilebilir. Ölçüler: – çap 100 mm – çıkıntı yeri içeriden maks. 4.5 mm
○ 150560AC	 2 modül, paslanmaz
○ 1505600T	 2 modül, piriç kaplı
○ 150560SB	 çimento için kutu
○ 150560S	 sıva altı kendinden modüllü buat
○ 150560F	 kesici kalınlık 86 mm





# BOYUTLAR

# ÜRÜN BOYUTLARI

## LIVINGLIGHT dikdörtgen çerçeveler

### DİKDÖRTGEN ÇERÇEVELER

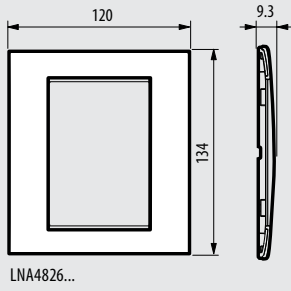
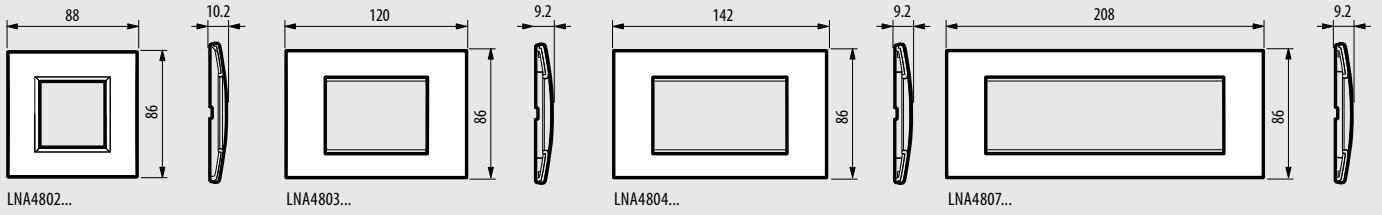

### 71 mm MERKEZ ARALIĞI - YATAY/DİKEY

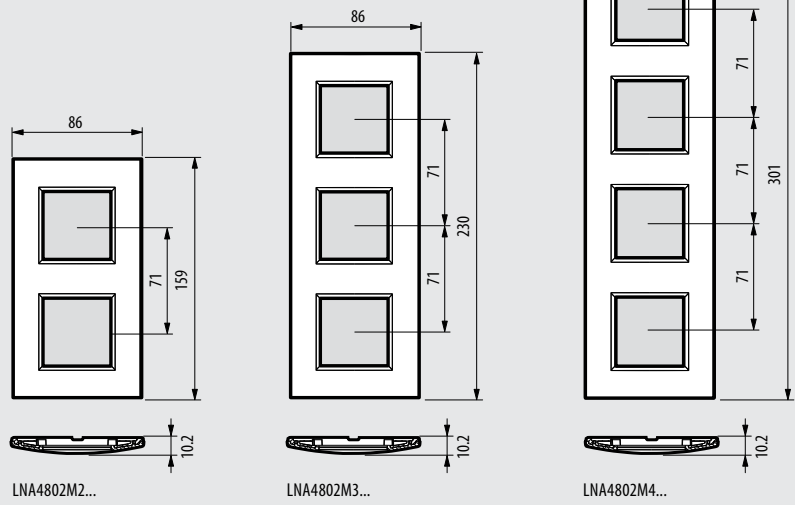

## LIVINGLIGHT ve AIR çerçeveler

### LIVINGLIGHT AIR ÇERÇEVELER (3 MODÜL KURULUM SİSTEMİ)

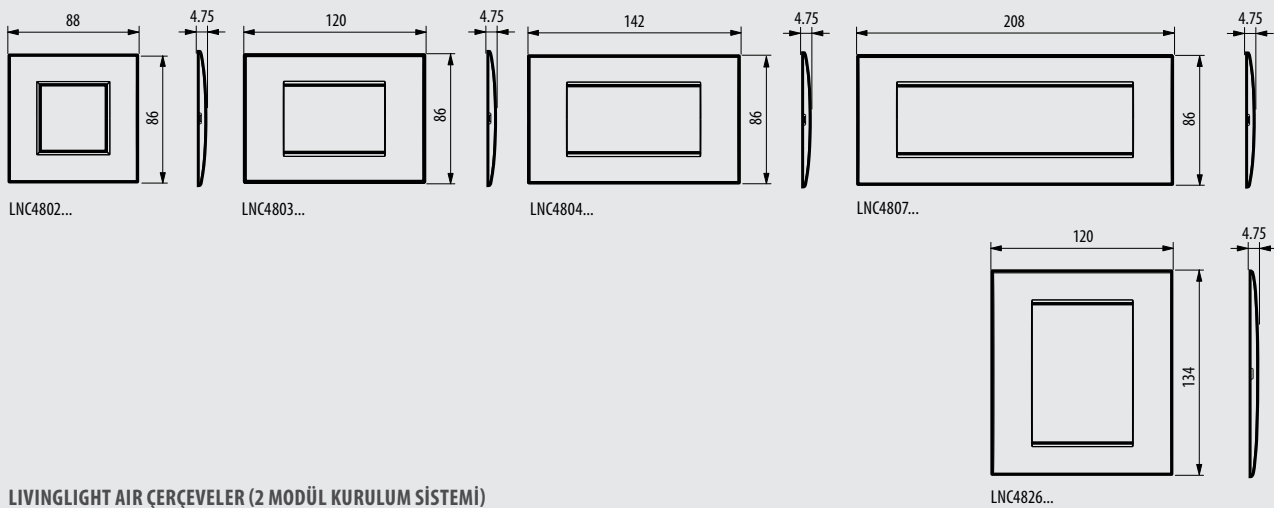

### LIVINGLIGHT AIR ÇERÇEVELER (2 MODÜL KURULUM SİSTEMİ)

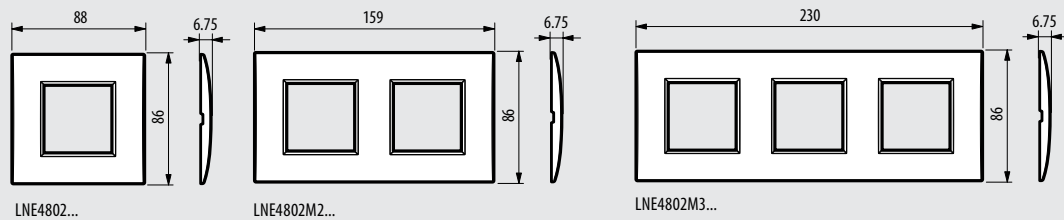

# ÜRÜN BOYUTLARI

## LIVING INTERNATIONAL

### LIVING INTERNATIONAL ÇERÇEVELER

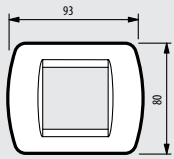

L4802..

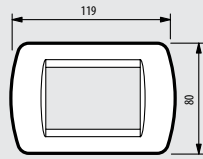

L4803..

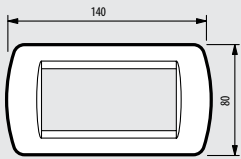

L4804..

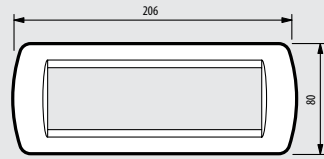

L4807..

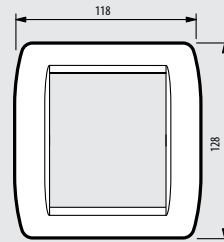

L4826..

### LIVINGLIGHT SIVA ÜSTÜ BUATLAR

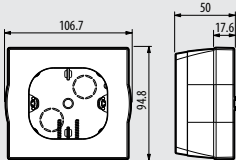

502BI

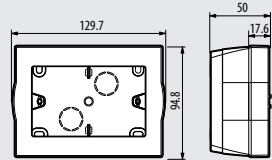

503BI

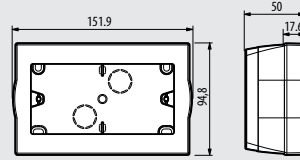

504BI

### SIVA ALTI BUATLAR

(2 modül AIR çerçeveler için)

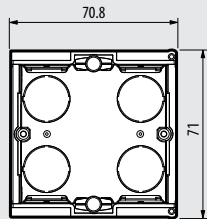

502E

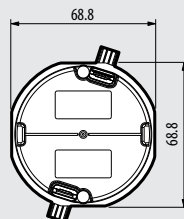
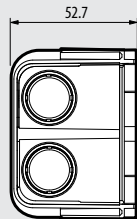

PB502

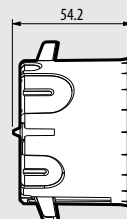

### LIVING INTERNATIONAL SIVA ÜSTÜ BUATLAR

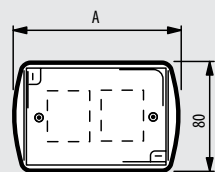

502LP  
503LP  
504LP

Item	A
<b>502LP</b>	93
<b>503LP</b>	120
<b>504LP</b>	140

# ÜRÜN BOYUTLARI

## LIVINGLIGHT AIR kaideler

### 2 modül kurulum sistemi

#### 2 MODÜL KAİDE

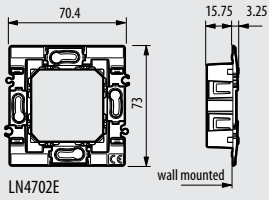

### 3 modül kurulum sistemi

#### 2 MODÜL KAİDE

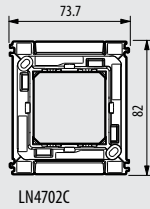

#### 3 MODÜL KAİDE

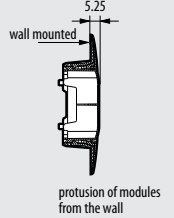
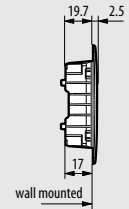
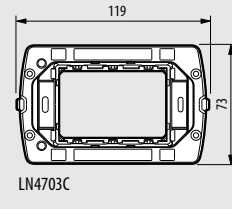

#### 4 MODÜL KAİDE

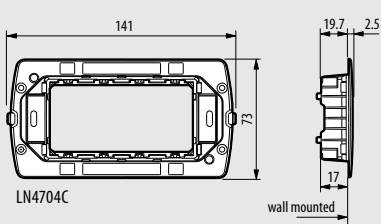

#### 7 MODÜL KAİDE

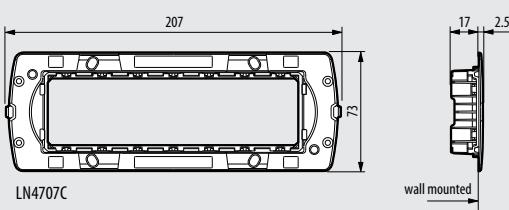

#### 3+3 MODÜL KAİDE

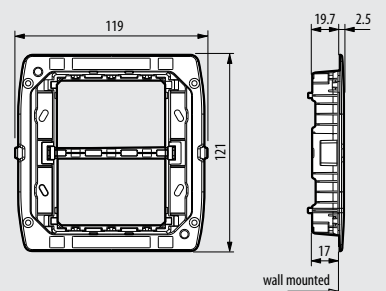

## LIVINGLIGHT ve LIVING INTERNATIONAL kaideler

#### 2 MODÜL KAİDE

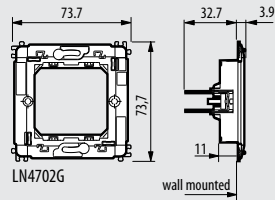
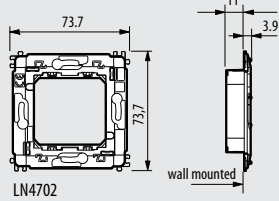

#### 3 MODÜL KAİDE

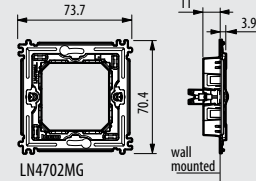
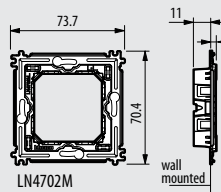
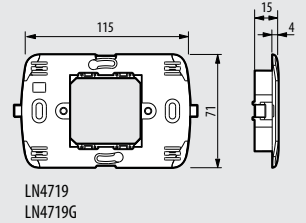
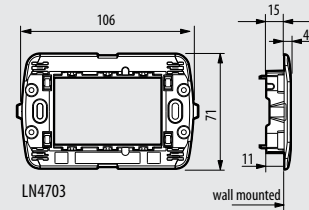

#### 4 MODÜL KAİDE

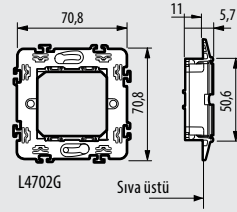
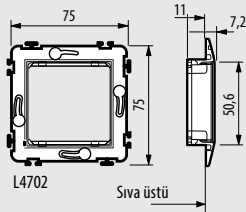
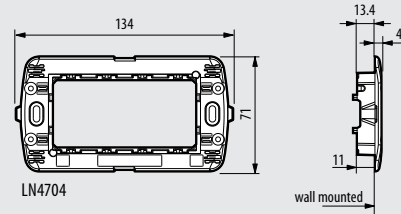

#### 7 MODÜL KAİDE

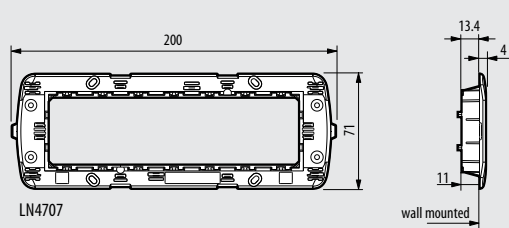

#### 3+3 MODÜL KAİDE

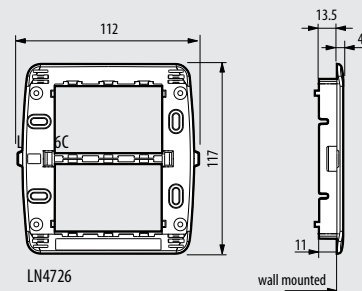

# BOYUT BİLGİLERİ

## MEKANİZMALAR

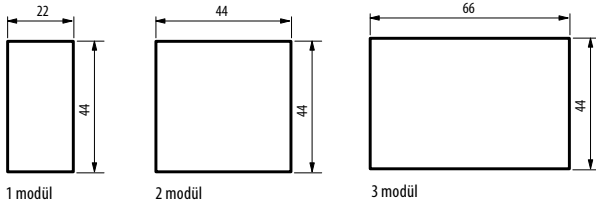

## SIVA ÜSTÜ MONTAJ İÇİN DERİNLİK

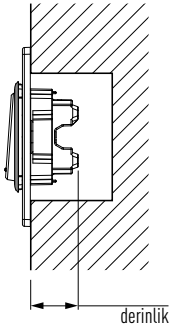

Ref.	LL kaide ile derinlik	AIR derinlik
L/N/N4003A	24,6	30,35
L/N/NT/N/NT4692	18,2	23,95
L/N/NT4001A	24,6	30,35
L/N/NT4005A	24,6	30,35
L/N/NT4011	28	33,75
L/N/NT4012	30	35,75
L/N/NT4016	32	37,75
L/N/NT4022	30	35,75
L/N/NT4027	32	37,75
L/N/NT4027VMC	32	37,75
L/N/NT4028H	32	37,75
L/N/NT4033	23	28,75
L/N/NT4036	25	30,75
L/N/NT4037	25	30,75
L/N/NT4038R	25	30,75
L/N/NT4038V	25	30,75
L/N/NT4051A	33,75	39,5
L/N/NT4051M2A	26,85	32,6
L/N/NT4053A	33,75	39,5
L/N/NT4053M2A	26,85	32,6
L/N/NT4054	33	38,75
L/N/NT4054M2	26	31,75
L/N/NT4055A	33	38,75
L/N/NT4055M2A	26,85	32,6
L/N/NT4113	25	30,75
L/N/NT4115	25	30,75
L/N/NT4119	25	30,75
L/N/NT4122ET	25,7	31,45
L/N/NT4125	22	27,75
L/N/NT4125S	22	27,75
L/N/NT4126	22	27,75
L/N/NT4126S	22	27,75
L/N/NT4127	22	27,75
L/N/NT4127S	22	27,75
L/N/NT4128	22	27,75
L/N/NT4128S	22	27,75
L/N/NT4129S	23,5	29,25
L/N/NT4132	23,8	29,55
L/N/NT4133	23,8	29,55
L/N/NT4134	23,8	29,55
L/N/NT4140	30	35,75
L/N/NT4140/16	30	35,75
L/N/NT4141	30	35,75
L/N/NT4141AN	32,35	38,1
L/N/NT4142	30	35,75

Ref.	LL kaide ile derinlik	AIR derinlik
L/N/NT4142AN	29,3	35,05
L/N/NT4143	30	35,75
L/N/NT4144	30	35,75
L/N/NT4145	30	35,75
L/N/NT4146	30	35,75
L/N/NT4150	27,3	33,05
L/N/NT4164/12	25,5	31,25
L/N/NT4164/13	39	44,75
L/N/NT4177	43,5	49,25
L/N/NT4177/127	43,5	49,25
L/N/NT4180	25	30,75
L/N/NT4180/2	27	32,75
L/N/NT4180/3	27	32,75
L/N/NT4183	31,7	37,45
L/N/NT4185	22	27,75
L/N/NT4185S	22	27,75
L/N/NT4188	22	27,75
L/N/NT4188S	22	27,75
L/N/NT4202D	30	35,75
L/N/NT4202D/2	28,5	34,25
L/N/NT4202DC	30	35,75
L/N/NT4202DC2	28,5	34,25
L/N/NT4202P	30	35,75
L/N/NT4202P/2	28,5	34,25
L/N/NT4202PT	30	35,75
L/N/NT4210D	22	27,75
L/N/NT4211D	22	27,75
L/N/NT4214D	28,5	34,25
L/N/NT4231	25,5	31,25
L/N/NT4231S	25,5	31,25
L/N/NT4258/11N	24	29,75
L/N/NT4261AT5	19	24,75
L/N/NT4261AT6	19	24,75
L/N/NT4262/11	32	37,75
L/N/NT4262/12	32	37,75
L/N/NT4268L/N/NTC	18,2	23,95
L/N/NT4268SC	11	16,75
L/N/NT4268ST	11	16,75
L/N/NT4269F	11	16,75
L/N/NT4269R	11	16,75
L/N/NT4284	10	15,75
L/N/NT4285	20	25,75
L/N/NT4285C	33	38,75
L/N/NT4285C2	33	38,75
L/N/NT4291	21	26,75

Ref.	LL kaide ile derinlik	AIR derinlik
L/N/NT4292	11	16,75
L/N/NT4293	11	16,75
L/N/NT4294	17,4	23,15
L/N/NT4301/10	34	39,75
L/N/NT4301/16	34	39,75
L/N/NT4301/6	34	39,75
L/N/NT4305/10	34	39,75
L/N/NT4305/16	34	39,75
L/N/NT4305/6	34	39,75
L/N/NT4311/10	34	39,75
L/N/NT4311/16	34	39,75
L/N/NT4321	27	32,75
L/N/NT4330/12	18	23,75
L/N/NT4330/230	18	23,75
L/N/NT4330/24	18	23,75
L/N/NT4341	31,4	37,15
L/N/NT4341/34	31,4	37,15
L/N/NT4351/12	32	37,75
L/N/NT4351/127	32	37,75
L/N/NT4351/230	32	37,75
L/N/NT4355/12	32	37,75
L/N/NT4356/12	32	37,75
L/N/NT4356/127	32	37,75
L/N/NT4356/230	32	37,75
L/N/NT4371A	25	30,75
L/N/NT4371R	25	30,75
L/N/NT4371T	25	30,75
L/N/NT4371V	25	30,75
L/N/NT4372AV	25	30,75
L/N/NT4372RT	25	30,75
L/N/NT4373H	27	32,75
L/N/NT4380	30	35,75
L/N/NT4391	25	30,75
L/N/NT4401	32	37,75
L/N/NT4402N	43	48,75
L/N/NT4406	43	48,75
L/N/NT4408N	37,1	42,85
L/N/NT4410N	37,1	42,85
L/N/NT4411N	37,1	42,85
L/N/NT4425	32	37,75
L/N/NT4431	32	37,75
L/N/NT4432	32	37,75
L/N/NT4432/127	32	37,75
L/N/NT4433	35,5	41,25
L/N/NT4434	35,5	41,25
L/N/NT4441	32	37,75
L/N/NT4442	32	37,75
L/N/NT4511/12	32	37,75
L/N/NT4512/12	32	37,75
L/N/NT4520	32	37,75
L/N/NT4536	24	29,75
L/N/NT4541	35,7	41,45
L/N/NT4545	32	37,75
L/N/NT4560	18,2	23,95
L/N/NT4562	24,9	30,65
L/N/NT4565	43	48,75
L/N/NT4607	18,2	23,95
L/N/NT4607/4	18,2	23,95
L/N/NT4610	18,2	23,95
L/N/NT4611	18,2	23,95
L/N/NT4612	18,2	23,95
L/N/NT4612/12	18,2	23,95
L/N/NT4613	18,2	23,95
L/N/NT4654N	18,2	23,95
L/N/NT4680	18,2	23,95
L/N/NT4692FAN	18,2	23,95
L/N/NT4693	18,2	23,95
L/N/NT4950	11	16,75

Ref.	LL kaide ile derinlik	AIR derinlik
L/N/NT4951	11	16,75
L/N/NT4953	11	16,75
L4001/0	25	30,75
L4003/0	25	30,75
L4005/0	25	30,75
L4140/16R	30	35,75
L4140R	30	35,75
L4141R	30	35,75
L4180R	25	30,75
L4374/230	25	30,75
L4382/230	25	30,75
L4384/1	41	46,75
L4384/3	50	55,75
L4385/127B	22	27,75
L4385/127R	22	27,75
L4385/127V	22	27,75
L4385/12B	22	27,75
L4385/12R	22	27,75
L4385/12V	22	27,75
L4385/230B	22	27,75
L4385/230R	22	27,75
L4385/230V	22	27,75
L4385/24B	22	27,75
L4385/24R	22	27,75
L4385/24V	22	27,75
L4386/1	41	46,75
L4386/1/127	41	46,75
L4386/3	50	55,75
L4386/3/127	41	46,75
L4572	13	/
L4572SB	13	/
L4573/2	32	37,75
L4575N	18,2	23,95
L4575SB	18,2	23,95
L4576N	18,2	23,95
L4581	32	37,75
L4582	32	37,75
L4583	32	37,75
L4614	18,2	23,95
L4615	18,2	23,95
L4618	18,2	23,95
L4652/2	18,2	23,95
L4652/3	18,2	23,95
L4671/1	24,9	30,65
L4678	32	37,75
LN4001A	25	30,75
LN4003A	25	30,75
LN4005A	25	30,75
4070	46	51,75
N/NT4070	46	51,75
NT4011S	33	38,75
NT4151	17,9	23,65
NT4152	17,9	23,65
NT4153	23	28,75
NT4178	39,8	45,55
NT4238M	29,5	35,25
NT4238S	29,5	35,25
NT4955/20	13	18,75
NT4955/45	25,2	30,95
334513 - 12 - 14	32	37,75
336983 - 82 - 84	29,5	35,25
336993 - 92 - 94	32	37,75
391613 - 12 - 14	32	37,75
391657 - 58 - 59	18,2	23,95
391667 - 68 - 69	18,2	23,95

**LEGRAND ELEKTRİK SAN. A.Ş.**  
**Pazarlama ve İstanbul Bölge Müdürlüğü**

Emek Mah. Ordu Cad. NO: 51  
34785 Sancaktepe-İstanbul  
Tel : 90 (212) 368 28 00 (pbx)  
: 90 (212) 251 34 30  
Faks: 90 (216) 621 66 29  
: 90 (216) 622 65 50

e-posta: info.turkiye@bticino.com.tr



www.bticino.com.tr

www.facebook.com/BTicinoTurkiye

www.twitter.com/BTicinoTurkiye

www.instagram.com/bticinotr

Versiyon 04/2018

**Bölge Müdürlükleri**

**Pazarlama ve Ticaret Müdürlüğü**

Emek Mah. Ordu Cad. No: 51  
34785 Sancaktepe - İSTANBUL  
Tel : (212) 368 28 00 (pbx)  
: (212) 251 34 30  
Faks : (216) 621 66 29  
: (216) 622 55 50

**Ankara Bölge Müdürlüğü**

Timko İşyerleri Sitesi,  
Anadolu Bulvarı Tarafı, A blok  
No: 12 Yenimahalle - ANKARA  
Tel : (312) 310 92 14  
: (312) 310 82 15  
: (312) 309 18 32  
: (312) 309 18 33  
Faks : (312) 312 28 88

**Bursa Bölge Müdürlüğü**

Üçevler mah. Bayraktepe sok.  
Akay İş Merkezi No: 7 D: 5  
Nilüfer - BURSA  
Tel : (224) 443 28 00  
: (224) 443 01 03  
: (224) 443 01 04  
Faks : (224) 443 01 05

**Ege Bölge Müdürlüğü**

1203/11. Sokak Ömer Atlı  
İş Merkezi No: 3 Kat: 7  
D: 708-709 35110  
Yenişehir - İZMiR  
Tel : (232) 469 23 33  
Faks : (232) 469 26 66

**Adana irtibat**

GSM : (533) 968 16 91

**Antalya irtibat**

Tel : (232) 469 23 33  
Faks : (232) 469 26 66

**Balıkesir irtibat**

GSM : (549) 748 88 02

**Diyarbakır irtibat**

Tel : (412) 235 74 83  
Faks : (412) 235 74 83  
GSM : (533) 968 16 79

**Eskişehir irtibat**

GSM : (537) 395 06 35

**Kayseri irtibat**

GSM : (549) 748 87 92

**Samsun irtibat**

GSM : (549) 727 85 19

**Trabzon irtibat**

GSM : (549) 748 83 73

**bticino**

Bir grup  
markasıdır | **legrand**